

Nitrous Oxide/ Oxygen Sedation Catalog

2025

Pricing Effective January 1, 2025

.....
PLUS Sterilization Center Water Solutions Insert

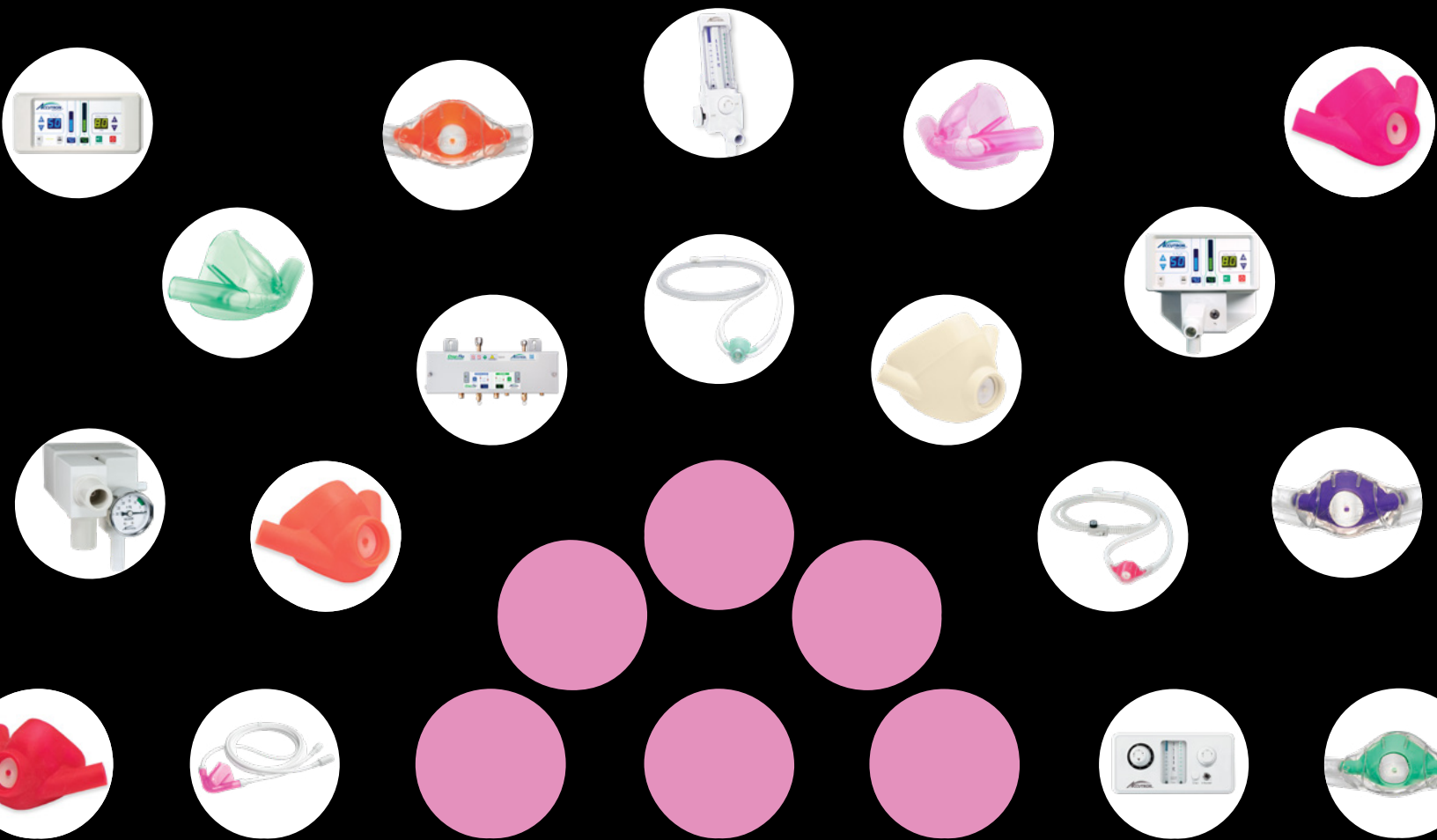

Accutron proud member of
HuFriedyGroup
The Best In Practice

To our valued Customers and Partners,

On behalf of all my global teammates, I would like to personally thank you for choosing HuFriedyGroup as your partner in delivering nitrous oxide/oxygen sedation solutions.

For those of you who might not have heard, Accutron is now a member of HuFriedyGroup after joining forces with Hu-Friedy, Crosstex and Palmero, to name a few, in 2019. The word "Group" encompasses the expanded value and commitment to dental professionals we are honored to provide together.

Our promise is to help clinicians be the Best in Practice. As our customers keep dentistry moving forward, we will be there every step of the way on this journey. I am so excited to see what the future holds.



Sincerely,

A handwritten signature in blue ink that reads "Andy Xilas". The signature is fluid and cursive.

Andy Xilas
President

Who We Are	3
Contact and Service Information	4
Flowmeters	7
Accutron™ Digital Ultra™ Flowmeters & Accessories	8
Accutron™ Newport™ Flowmeter Systems	15
Accutron™ Ultra PC™ Cabinet Mount Flowmeter & Accessories	17
Accutron™ Ultra PC™ % Flowmeter	20
Accutron™ Ultra DC™ Flowmeter	24
Oral Surgery Flowmeters & Accessories	26
Vacuum Controllers & Mounts	31
Vacuum Controllers	32
RFS™ Remote Flow System Chairmount Kits	33
Universal Cabinet Slide Mounts	38
Flowmeter Mounts & Stands	39
Manifold Systems	41
Accutron™ Digi-Flo™ Digital Automatic Switching Manifold Systems	42
Accutron™ Guardian Monitor™ Manifold/Alarm System	44
Hoses, Connectors & Outlet Stations	49
Hoses & Connectors	50
Recessed, Surface & Micro Outlet Stations	54
Nasal Masks	57
Accutron™ Axess™ Low Profile Nasal Masks	58
Accutron™ ClearView™ Single-Use Nasal Masks	59
Accutron™ PIP+™ Nasal Masks	60
Capnography Adapters & Bundles	62
Scavenging Circuits	65
Accutron™ Axess™ Scavenging Circuits	66
Accutron™ ClearView™ Scavenging Circuits	68
Accutron™ PIP+™ Scavenging Circuits	70
Oxygen Equipment & Components	73
Rubber Goods & Other Components	79
Rubber Goods & Other Components	80
Top Replacement Parts	82

Pricing Effective Date: January 1, 2025

Note: Pricing is subject to change without notice. Please consult most up-to-date price list.

Canadian Sales Note: Some of the devices and/or products advertised may not be licensed for sale in accordance with Canadian law.

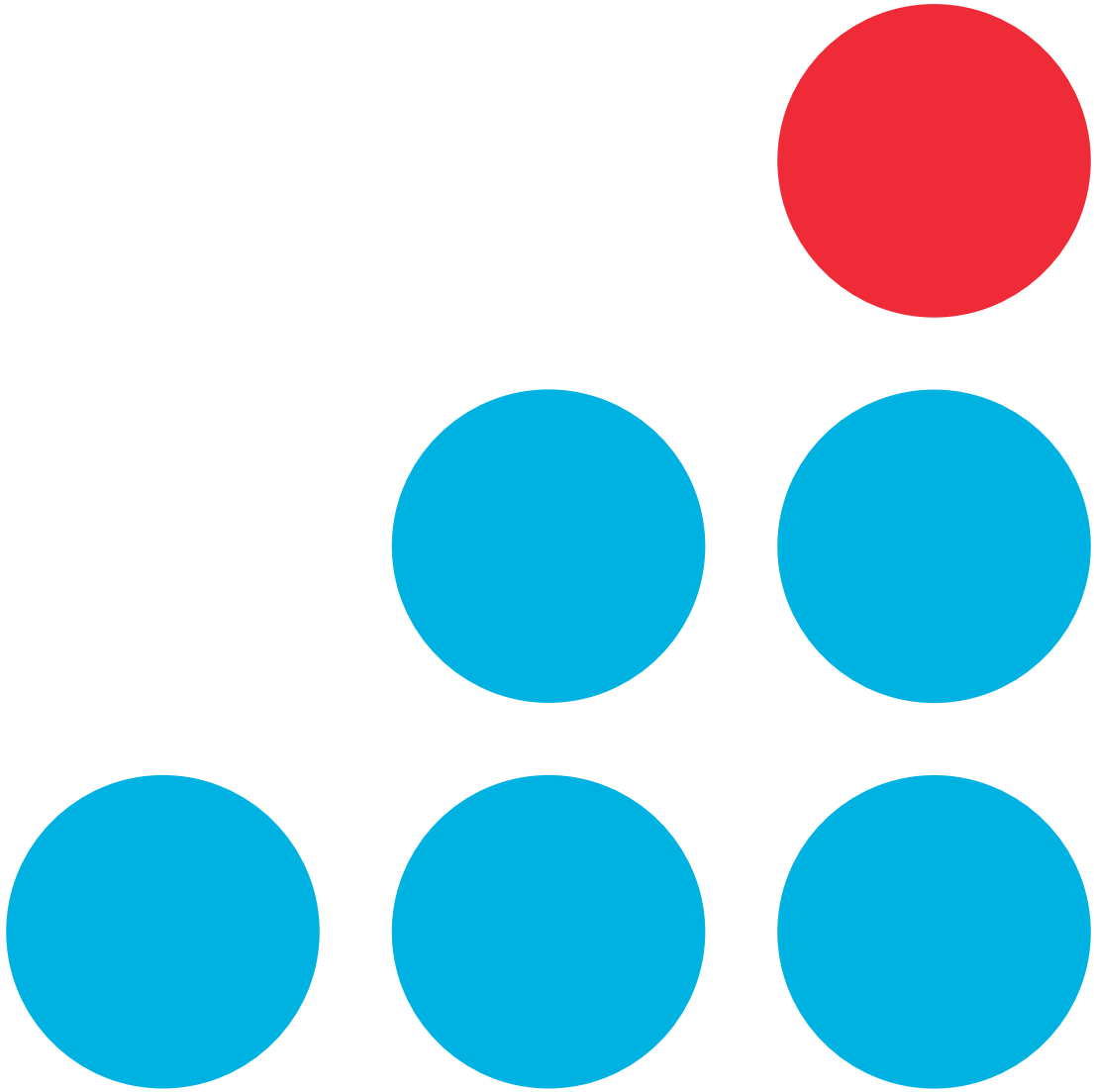

ACCUTRON
Nitrous Oxide/Oxygen Sedation

CROSSTEX

Hu-Friedy

PALMERO
HEALTHCARE



Who We Are

HuFriedyGroup is a leading global manufacturer of dental instruments, instrument management systems, infection control products, conscious sedation, and small equipment.

HuFriedyGroup helps dental professionals be the best in practice by bringing together world-class products, services, education, and communities that result in superior clinician performance, reduced risk, improved efficiencies, drive compliance, and enhance patient and staff safety.

Headquartered in Chicago, HuFriedyGroup products are distributed in approximately 100 countries, and is supported by a base of approximately 1,600 employees across over 20 global manufacturing facilities and locations.



Conscious Sedation Delivery Options

Accutron has been a market leader of innovative nitrous oxide/oxygen sedation products including single-use nasal masks, scavenging systems, manifolds, flowmeter systems and associated components. Now a member of HuFriedyGroup, the Accutron product line offers flexible options for each and every practice.

Contact and Service Information



Call our Customer Care team at
(800) 531-2221.
Hours of Operation: 7:00 AM - 5:00 PM CST



Email our Customer Care team at
orders@accutron-inc.com.



For NA equipment sales inquiries,
please visit **www.HuFriedyGroup.com/Wheretobuy/Accutron**.



Learn more about our entire line of
Accutron™ Products.

Service Ship-to Address

1733 W. Parkside Ln.
Phoenix, AZ 85027



To initiate a repair, please visit
www.HuFriedyGroup.com/accutrons-service.



Accutron Flowmeters carry a 2-year warranty,
and Manifolds and other items carry a 1-year
warranty. For the full warranty, visit:
www.HuFriedyGroup.com/Services/Warranties.



Portable

- Can move between operatories for increased flexibility.
- Occupies less space and no requirement for central storage unit.
- Utilizes E cylinders and is an optimal solution when frequency of administration is low.
- Available in enclosed option to keep cylinders out of sight and make disinfection faster.



Centralized

- Optimal solution when nitrous oxide/oxygen sedation is used frequently.
- Requires central storage area for cylinders and initial investment in gas storage system.
- Utilizes G and H cylinders so more cost-effective over time.



Chairside

- Eliminate long mixed gas and vacuum hoses draping from adjacent cabinets.
- Create uncluttered, safer work zone for doctor and staff.
- Minimize displacement of patient mask caused by drag/pull and weight of long hoses.
- Kits available for a wide variety of dental chair brands.

Accutron™ Digital Ultra™ Flowmeters & Accessories	8
Accutron™ Digital Ultra™ Flushmount Flowmeter	8
Accutron™ Digital Ultra™ Flowmeter	13
Accutron™ Newport™ Flowmeter Systems	15
Accutron™ Newport™ Digital Flowmeter System	16
Accutron™ Newport™ Flowmeter System	16
Accutron™ Ultra PC™ Cabinet Mount Flowmeter & Accessories	17
Accutron™ Ultra PC™ % Flowmeter	20
Accutron™ Ultra DC™ Flowmeter	24
Oral Surgery Flowmeters & Accessories	26
Oral Surgery Flowmeter Systems	26
Ultra PC™ % Oral Surgery Flowmeter Packages	27
Ultra DC™ % Oral Surgery Flowmeter Packages	28
Oral Surgery Accessories	29
Oral Surgery Suction Accessories	29

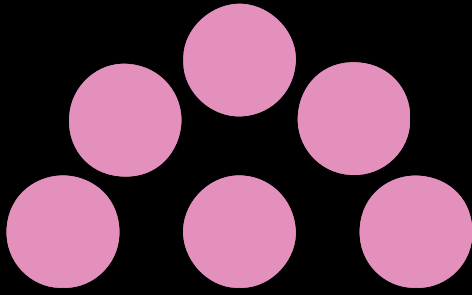

Flowmeters

We offer a full line of equipment solutions to implement conscious sedation into your practice - your way.

Our Accutron™ Digital Ultra™ Flowmeters are available in both mounted and portable configurations so you can choose what best fits your operatory set up.



Accutron™ Digital Ultra™ Flowmeters & Accessories

The Accutron™ Digital Ultra™ Flowmeters are designed for clinicians who prefer to work in a digital environment but want critical parameters displayed both numerically and as electronic flow tubes. With multiple configurations available to suit the needs of your practice, the Accutron™ Digital Ultra™ Flowmeter also features color-coded, fingertip controls, a sealed flush surface for easy disinfection or barrier protection and a clean, contemporary design.

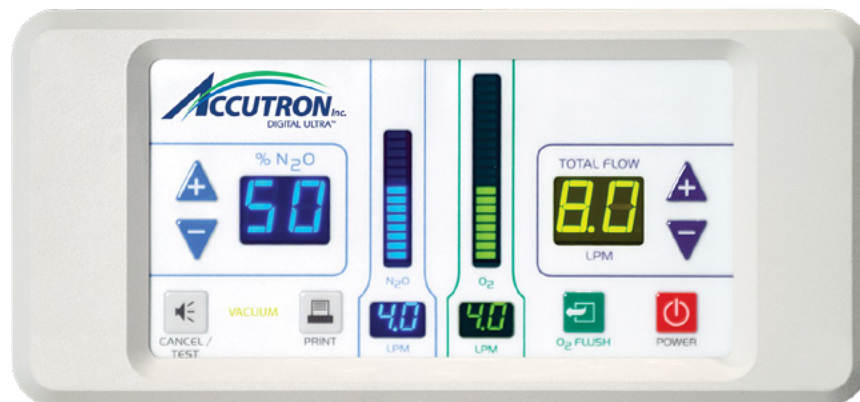

Accutron™ Digital Ultra™ Flushmount Flowmeter

Our Accutron™ Digital Ultra™ Flushmount Flowmeters features automatic compensation to easily adjust total flow or gas ratio while the other stays constant and include both digital and electronic flowtube displays for ease of use.

For patient safety, the maximum nitrous oxide ratio is 70%. Audible and visual alarms provide notification of low oxygen. For additional safety, these Flowmeters feature oxygen fail-safe and flush.



Learn more about our [Accutron™ Digital Ultra™ Flowmeters](#).



Dimensions Flushmount Control Module:
9.25 in x 4 in x 1.5 in (23.5 cm x 10.2 cm x 3.8 cm)
Dimensions Remote Main Module:
8 in x 4 in x 7.5 in (20.3 cm x 10.2 cm x 19.1 cm)
Mounted Dimensions:
(W x H x D): 9.5 in x 4.25 in x .25 in (24.1 cm x 10.8 cm x .64 cm)
Weight Flushmount Control Module: 1.3 lbs (0.6 kg)
Weight Remote Main Module: 6.1 lbs (2.8 kg)
Mixed Gas Outlet Diameter: .875 in Nominal (22mm)
Oxygen Inlet: Male DISS (CGA 1240)

Nitrous Oxide Inlet: Male DISS (CGA 1040)
Nitrous Oxide Mixed Ratio Range: 0-70%
Oxygen Flow Range: 1.0 to 9.9 LPM
Nitrous Oxide Flow Range: 0 to 6.9 LPM
Inlet Pressure (each gas): 50 to 55 psi
Resuscitator Connector:
Quick Connect (.25 in Imperial) at Remote Outlet
Resuscitator Connector Flow: 100 LPM Oxygen
Power Requirements: 100-240 V AC, 50-60 Hz, 30 Watts

<p>A  Accutron™ Digital Ultra™ Flushmount Flowmeter 27076</p>	<p>D  RFS™ Remote Flow 36855-CHAIR</p>	<p>G  Accutron™ Clearview™ Scavenging Circuit II 43004 <i>(for RFS™ System D and Accu-Vac™ Vacuum Controller)</i></p>
<p>B  Bag Tee 26679 & Remote Block 27187</p>	<p>E  Accu-Vac™ Vacuum Controller 56955</p>	<p>H  Check Valve Risers 23173-FRU 23174-FRU</p>
<p>C  RFS™ Remote Flow (Digital) 56855</p>	<p>F  Accutron™ Clearview™ Scavenging Circuit II (Standard) 43003 <i>Includes a complimentary sampling of single-use nasal masks.</i></p>	<p>I  Oxygen Outlet 27793-FRU</p>

Central Systems





<p>56800 TOP SELLER \$7,610.00</p> <p>Accutron™ Digital Ultra™ Flushmount Package H Accutron™ Digital Ultra™ Flushmount Flowmeter, Mounting Hardware, Check Valve Risers, RFS™ Remote Flow System D (with O₂ port), RFS™ Flush Panel Mount Faceplate, one 10 ft O₂ hose, 10 ft of Mixed Gas Hose, One 6 ft N₂O Hose, One 6 ft O₂ Hose and Accutron™ Clearview™ Scavenging Circuit II (for RFS™-D) <i>Includes A C G H</i></p>	<p>56600 Accutron™ Digital Ultra™ Flushmount Package G \$7,266.00 Accutron™ Digital Ultra™ Flushmount Flowmeter, Mounting Hardware, Check Valve Risers, Bag Tee, Accutron™ Clearview™ Scavenging Circuit II (standard) <i>Includes A B F H</i></p>
<p>56800-CHAIR TOP SELLER \$7,876.00</p> <p>Accutron™ Digital Ultra™ Flushmount Package H CHAIR Accutron™ Digital Ultra™ Flushmount Flowmeter, Mounting Hardware, RFS™ Remote Flow System A, Oxygen Outlet, O₂ and N₂O Check Valve Risers, 25 ft of Vacuum Hose, 25 ft of Mixed Gas Hose, One 6 ft N₂O Hose, Two 6 ft O₂ Hoses, and Accutron™ Clearview™ Scavenging Circuit II (for RFS™-A) <i>Includes A D G H I</i> <i>CHAIRMOUNT KITS SOLD SEPARATELY.</i></p>	<p>56950 Accutron™ Digital Ultra™ Flushmount Package I \$8,234.00 Accutron™ Digital Ultra™ Flushmount Flowmeter, Mounting Hardware, Check Valve Risers, Accu-Vac™ Vacuum Controller, Accu-Vac™ Vacuum Controller Flush Panel Mount Faceplate, Accutron™ Clearview™ Scavenging Circuit II (for Accu-Vac™ Vacuum Controller) <i>Includes A E G H</i></p>
<p>56800-CKK 56800 Chair Conversion Kit \$1,254.00 <i>Converts cabinet mount package to a chair package. Includes: Oxygen outlet, hoses, proper fittings and decals.</i></p>	



Digital Flushmount Flowmeters (without pre-installation kits)

56600-NS	Digital Ultra™ Flushmount Flowmeter Pkg. G <i>(includes mounting hardware)</i>	\$6,922.00
56800-NS	Digital Ultra™ Flushmount Flowmeter Pkg. H <i>(includes mounting hardware, Remote Flow System and RFS™ Flush Mount Faceplate)</i>	\$7,258.00
56800-CHAIR-NS	Digital Ultra™ Flushmount Flowmeter Pkg. H CHAIR <i>(includes mounting hardware, Remote Flow System and RFS™ Flush Mount Faceplate)</i>	\$7,522.00
56950-NS	Digital Ultra™ Flushmount Flowmeter Pkg. I <i>(includes mounting hardware, Accu-Vac™ Vacuum Controller and Accu-Vac™ Flush Mount Faceplate)</i>	\$7,872.00

Flowmeter Pre-installation Kit Components

23173-FRU	TOP SELLER O₂ Check Valve Riser - DISS <i>(for operator); includes 28085</i>	\$184.00
		
23174-FRU	TOP SELLER N₂O Check Valve Riser - DISS <i>(for operator); includes 28086</i>	\$184.00
		
28085-FRU	O₂ DISS x DISS Demand Check Valve Assembly	\$114.00
		
28086-FRU	N₂O DISS x DISS Demand Check Valve Assembly	\$114.00
		



Accessories

23173-FRU	TOP SELLER O₂ Check Valve Riser - DISS <i>(for operator); includes 28085</i>	\$184.00	32015	Universal Cabinet Slide, Accu-Vac™ Vacuum Controller <i>(slide mounts to left, right, or under cabinet)</i> <i>Use with 56955 and 56950 flowmeter package</i>	\$674.00
23174-FRU	TOP SELLER N₂O Check Valve Riser - DISS <i>(for operator); includes 28086</i>	\$184.00	32018	TOP SELLER Universal Cabinet Slide, Digital RFS™ System <i>(slide mounts to left, right, or under cabinet)</i> <i>Use with 56855 and 56800 flowmeter package</i>	\$674.00
25043	Universal Light Pole Mount Kit for RFS™ - D	\$608.00	32019	Universal Cabinet Slide, Digital Bag Tee <i>(slide mounts to left, right, or under cabinet)</i> <i>Use with 27187 and 56600 flowmeter package</i>	\$674.00
27193	Bracket for Digital Ultra™ Flushmount Flowmeter <i>(use for mounting flowmeter in wall)</i>	\$160.00			
27793-FRU	Oxygen Outlet <i>(for use with Digital Ultra™ Flushmount, RFS™ System A & RFS™ Chairmount Kits)</i>	\$390.00	32055	Surface Mount for Digital Ultra™ Flushmount <i>(flowmeter not included)</i>	\$482.00
27328	Main Module Mounting Bracket	\$98.00	54500	Remote Control for Digital Ultra™ Flowmeter	\$618.00
28085-FRU	O₂ DISS x DISS Demand Check Valve Assembly	\$114.00	20212	Reinforced Spiral Vacuum Tube <i>Order by the foot.</i>	\$12.00
28086-FRU	N₂O DISS x DISS Demand Check Valve Assembly	\$114.00			

Accutron™ Digital Ultra™ Flushmount Flowmeter Template

Slimline design separates control module from gas supply module and offers:

- More accessible cabinet space
- Flexible installation choices
- Mounting in wall as an option

Options for vacuum system controllers include: Standard Bag Tee, Accu-Vac™ Vacuum Controller or RFS™ Remote Flow System.

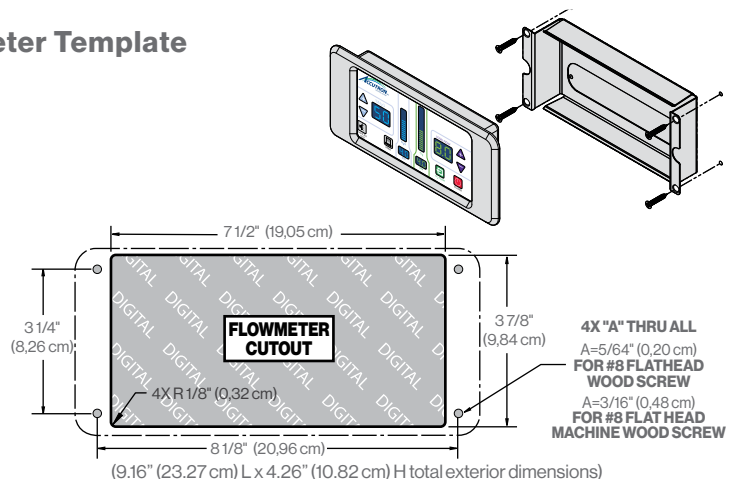



Accutron™ Digital Ultra™ Flushmount Flowmeter, 56800-CHAIR

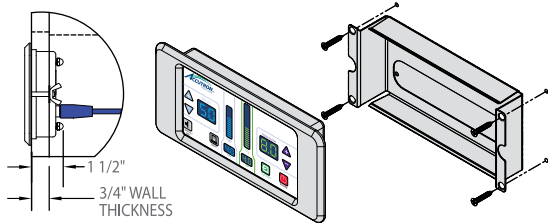
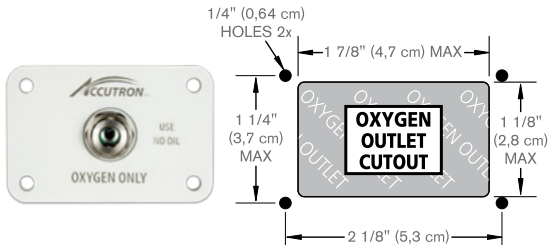
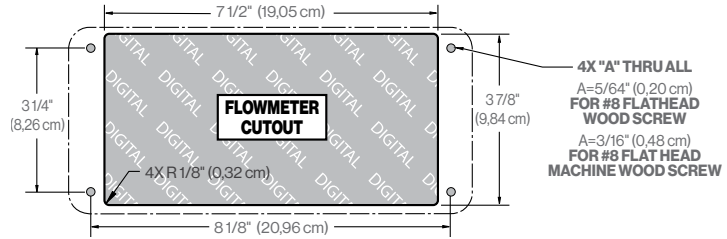

1. In advance of construction:

- a) Provide for tubing chase from flowmeter location to chair J-Box.
- b) Install Vacuum, Oxygen, and Nitrous Oxide risers.

2. Installation:

- a) Ensure cut-outs for the flowmeter and oxygen outlet are located correctly.
- b) Mount Control Module Bracket, with long slot down. Feed cable through the slot. Connect cable to controller and press controller into bracket. Make sure cable is not pinched. To remove controller from the bracket, insert screwdriver into slot at bottom corner of controller and pry outward.
- c) Pull the Mixed Gas and Vacuum lines up to the Remote Flow System mounting location on the chair.
- d) Install Remote Flow System to chair. (Requires purchase of brand-specific Chairmount Kit).
- e) Complete connections of all hoses.

Accutron™ Digital Ultra™ Flushmount Flowmeter with RFS™ Mounted in Cabinet

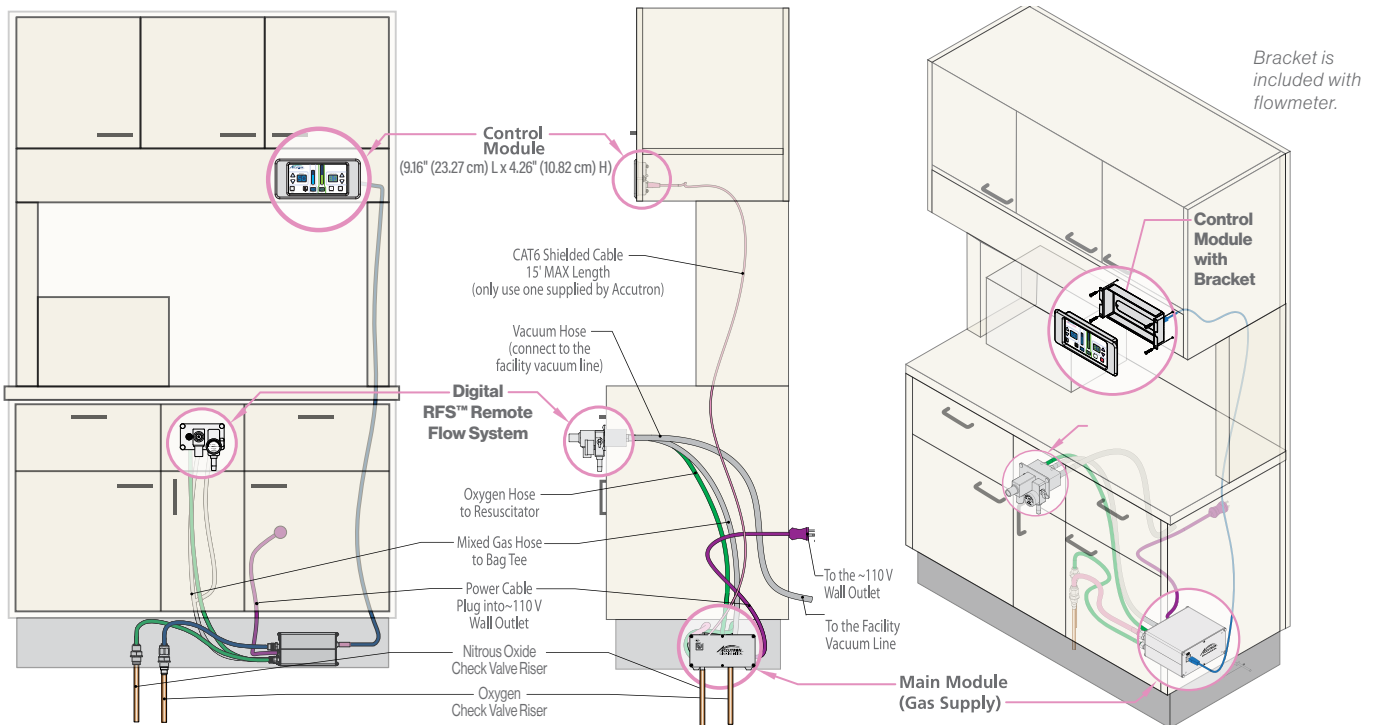

In-cabinet illustrations are specific to 56800 Digital Ultra™ Flushmount with RFS™ Remote Flow System Vacuum Controller.

All templates are not to scale.



Accutron™ Digital Ultra™ Flowmeter

Our Accutron™ Digital Ultra™ Flowmeter features automatic compensation to easily adjust total flow or gas ratio while the other stays constant and both digital and electronic flowtube displays for ease of use. For patient safety, the maximum nitrous oxide ratio is 70%. Audible and visual alarms provide notification of low oxygen. For additional safety, these Flowmeters feature oxygen fail-safe and flush.

Also includes emergency oxygen resuscitation connector as well as a sealed flush surface to make it easy to disinfect or barrier-protect.

Dimensions Control Module:
7.5 in x 7 in x 8.75 in (19.1 cm x 17.8 cm x 22.2 cm)
Weight: 6.3 lbs
Mixed Gas Outlet Diameter: .875 in Nominal (22mm)
Oxygen Inlet: Male DISS (CGA 1240)
Nitrous Oxide Inlet: Male DISS (CGA 1040)
Nitrous Oxide Mixed Ratio Range: 0 to 70%

Oxygen Flow Range: 1.0 to 9.9 LPM
Nitrous Oxide Flow Range: 0 to 6.9 LPM
Inlet Pressure (each gas): 50 to 55 psi
Resuscitator Connector: Quick Connect (.25 in Imperial)
Resuscitator Connector Flow: 100 LPM Oxygen
Power Requirements: 100-240 V AC, 50-60 Hz, 30 Watts



A



Accutron™ Digital Ultra™ Flowmeter
51975

D



Mobile Stand
32005
Height with Flowmeter:
35.75 in,
W x D: 22 in x 22 in

G



16 in Bi-fold Wall Arm
32001

B



4-Cylinder Portable System
54000

Height with Flowmeter:
36.375 in,
W x D: 22 in x 22 in

E



Adjustable Mobile Stand
42005

Height with Flowmeter:
H: 19.5 in to 30 in
W x D: 22 in x 22 in

H



Telescoping Wall Arm
32003

(Extends 12 in to 17 in)

C



Accutron™ Clearview™ Scavenging Circuit II (Standard)
43003

Includes a complimentary sampling of single-use nasal masks.

F



9 in Wall Arm
32002

Flowmeter Only

51975 **Accutron™ Digital Ultra™ Flowmeter** **\$4,830.00**
Includes **A**

Portable Systems

56100 **TOP SELLER** **\$8,754.00**
Accutron™ Digital Ultra™ Flowmeter Package B
Digital Ultra™ Flowmeter, 4-Cylinder Portable System, Accutron™ Clearview™ Scavenging Circuit II
Includes **A B C**

Central Systems

56200 **Accutron™ Digital Ultra™ Flowmeter Package C** **\$5,892.00**
Digital Ultra™ Flowmeter, Mobile Stand, Accutron™ Clearview™ Scavenging Circuit II
Includes **A C D**

56400 **Accutron™ Digital Ultra™ Flowmeter Package E** **\$5,892.00**
Digital Ultra™ Flowmeter, 16 in Bi-fold Wall Arm, Mounting Adapter 24552, Accutron™ Clearview™ Scavenging Circuit II
Includes **A C G**

56200-ADJS **Accutron™ Digital Ultra™ Flowmeter Package C ADJS** **\$5,892.00**
Digital Ultra™ Flowmeter, Adjustable Mobile Stand – Short, Accutron™ Clearview™ Scavenger Circuit II
Includes **A C E**

56500 **Accutron™ Digital Ultra™ Flowmeter Package F** **\$5,892.00**
Digital Ultra™ Flowmeter, Telescoping Wall Arm, Mounting Adapter 24552, Accutron™ Clearview™ Scavenging Circuit II
Includes **A C H**

56300 **Accutron™ Digital Ultra™ Flowmeter Package D** **\$5,892.00**
Digital Ultra™ Flowmeter, 9 in Wall Arm, Mounting Adapter 24552, Accutron™ Clearview™ Scavenging Circuit II
Includes **A C F**

Order quick connect hoses for Packages C-F separately.



Accutron™ Newport™ Flowmeter Systems



A
Accutron™
Newport™
Digital
Flowmeter
System



B
Accutron™
Newport™
Flowmeter
System



Scavenging Circuit II (Standard)
*Includes a complimentary sampling
of single-use nasal masks.*



Accutron™ Newport™ Digital Flowmeter System

The Accutron™ Newport™ Digital Flowmeter System has all of the operating features of the Accutron™ Digital Ultra™ Flowmeter, plus its enclosed 4-cylinder design makes it a user-friendly portable that can easily be moved from operator to operator. The unit's height allows it to be stored under counter space that is open below. If not stored, its flat surface can function as additional counter space.

Product Specifications

Dimensions H x D x W: 31.75 in x 24 in x 19.25 in
(80.6 cm x 61 cm x 48.9 cm)

51000	Accutron™ Newport™ Digital Flowmeter System 4-Cylinder Enclosed Portable, Scavenging Circuit II <i>Includes A C</i>	\$10,766.00
25746	FRU Newport O₂ Regulator	\$464.00
25747	FRU Newport N₂O Regulator	\$464.00

Accutron™ Newport™ Flowmeter System

The Accutron™ Newport™ Flowmeter System has all of the operating features of the Ultra PC™ % Flowmeter, plus its enclosed 4-cylinder design makes it a user-friendly portable that can easily be moved from operator to operator. The unit's height allows it to be stored under counter space that is open below. If not stored, its flat surface can function as additional counter space.

Product Specifications

Dimensions H x D x W: 31.75 in x 24 in x 19.25 in
(80.6 cm x 61 cm x 48.9 cm)

50000	Accutron™ Newport™ Flowmeter System 4-Cylinder Enclosed Portable, Scavenging Circuit II <i>Includes B C</i>	\$9,784.00
--------------	---	-------------------



Accutron™ Ultra PC™ Cabinet Mount Flowmeter & Accessories

Our Accutron™ Ultra PC™ % Cabinet Mount Flowmeter features single-knob total flow control and nitrous oxide ratio control with 70% maximum. This Flowmeter also includes oxygen fail-safe, oxygen flush, oxygen resuscitation connector, emergency air valve, directional check valve and continuous oxygen and nitrous oxide flow tubes. Accessories for this product are also available.

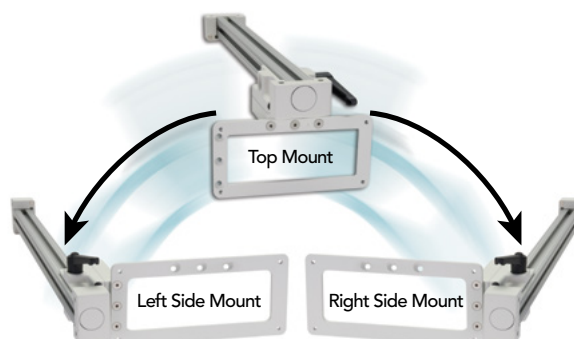

- Featured Mounting Option: Universal Cabinet Slides
- Three cabinet mounting positions



Dimensions Flushmount Control Module:
 7.5 in x 7 in x 8.75 in (19.1 cm x 17.8 cm x 22.2 cm)
 Weight: 6.3 lbs
 Mixed Gas Outlet Diameter: .875 in Nominal (22mm)
 Oxygen Inlet: Male DISS (CGA 1240)
 Nitrous Oxide Inlet: Male DISS (CGA 1040)
 Nitrous Oxide Mixed Ratio Range: 0 to 70%

Oxygen Flow Range: 1.0 to 9.9 LPM
 Nitrous Oxide Flow Range: 0 to 6.9 LPM
 Inlet Pressure (each gas): 50 to 55 psi
 Resuscitator Connector: Quick Connect (.25 in Imperial)
 Resuscitator Connector Flow: 100 LPM Oxygen
 Power Requirements: 100-240 V AC, 50-60 Hz, 30 Watts

A

Accutron™ Ultra PC™ % Cabinet Mount Flowmeter



D

Accutron™ ClearView™ Scavenging Circuit II (Standard)

43003

Includes a complimentary sampling of single-use nasal masks.



G

O₂ DISS & N₂O DISS x DISS Demand Check Valve Assembly

28085-FRU

28086-FRU



B

Bag Tee

26679



E

Accutron™ ClearView™ Scavenging Circuit II (RSF™ System A)

43004



H

Universal Cabinet Slide, Analog Bag Tee

32008



C

RFS™ Remote Flow System A

36855



F

O₂ & N₂O Check Valve Risers

23173-FRU

23174-FRU



I

Universal Cabinet Slide, Remote Flow System (RFS™ System A)

32014



Central Systems

31970	Accutron™ Ultra PC™ % Cabinet Mount Flowmeter Only <i>Includes A</i>	\$4,414.00
36600	Accutron™ Ultra PC™ % Cabinet Mount Flowmeter Package G Accutron™ Ultra PC™ % Cabinet Mount Flowmeter, Mounting Hardware, Check Valve Risers, Bag Tee, Accutron™ ClearView™ Scavenging Circuit II (standard) <i>Includes A B D F</i>	\$6,298.00
36800	Accutron™ Ultra PC™ % Cabinet Mount Flowmeter Package H Accutron™ Ultra PC™ % Cabinet Mount Flowmeter, Mounting Hardware, Check Valve Risers, RFS™ Remote Flow System A, Accutron™ ClearView™ Scavenging Circuit II (for RFS™ System A) <i>Includes A C E F</i>	\$6,738.00
36800-CHAIR	Accutron™ Ultra PC™ % Cabinet Mount Flowmeter Pkg. H CHAIR Accutron™ Ultra PC™ % Cabinet Mount Flowmeter, Mounting Hardware, RFS™ Remote Flow System A, O ₂ and N ₂ O Check Valve Risers, 25' of Vacuum Hose, 5' of Mixed Gas Hose, One 6' N ₂ O Hose, One 6' O ₂ Hose, and Accutron™ ClearView™ Scavenging Circuit II (for RFS™ System A) <i>Includes A C E F</i> CHAIRMOUNT KIT SOLD SEPARATELY.	\$7,042.00

Accessories

23173-FRU	O ₂ Check Valve Riser - DISS includes 28085	\$184.00
23174-FRU	N ₂ O Check Valve Riser - DISS includes 28086	\$184.00
28085-FRU	O ₂ DISS x DISS Demand Check Valve Assembly	\$114.00
28086-FRU	N ₂ O DISS x DISS Demand Check Valve Assembly	\$114.00
25043	Universal Light Pole Mount Kit for Remote Flow System (RFS™ System A)	\$608.00
32008	Universal Cabinet Slide, Analog Bag Tee (slide mounts to left, right, or under cabinet) <i>Use with 26679-FRU and 36600 flowmeter package</i>	\$676.00
32014	Universal Cabinet Slide, Analog RFS™ System (slide mounts to left, right, or under cabinet) <i>Use with 36855 and 36800 flowmeter package</i>	\$674.00
36800-CCK	36800 Chair Conversion Kit (Converts cabinet mount package to a chair package. Includes: Oxygen outlet, tubing, proper fittings and decals)	\$1,220.00

To order above Ultra PC™ % Cabinet Mount packages without pre-install kits and flowmeter pre-install kit components, see page 22.



Flowmeters without Pre-Installation Kits & Pre-Install Kit Components



Cabinet Mount Flowmeters (without pre-installation kits)

36600-NS	Ultra PC™ % Cabinet Mount Flowmeter Pkg. G <i>(includes mounting hardware)</i>	\$5,916.00
36800-NS	Ultra PC™ % Cabinet Mount Flowmeter Pkg. H <i>(includes RFS™ Remote Flow System and mounting hardware)</i>	\$6,422.00
36800-CHAIR-NS	Ultra PC™ % Cabinet Mount Flowmeter Pkg. H CHAIR <i>(includes RFS™ Remote Flow System and mounting hardware)</i>	\$6,722.00



Accutron™ Ultra PC™ % Flowmeter

Our Accutron™ Ultra PC™ % Flowmeter features single-knob total flow control and nitrous oxide ratio control with 70% maximum. This Flowmeter also includes oxygen fail-safe, oxygen flush, oxygen resuscitation connector, emergency air valve, directional check valve and continuous oxygen and nitrous oxide flow tubes.

Dimensions: 4.25 in x 10.5 in x 8 in (10.8 cm x 26.7 cm x 20.3 cm)
Weight: 4.5 lbs
Mixed Gas Outlet Diameter: .875 in Nominal (22mm)
Oxygen Inlet: Male DISS (CGA 1240)
Nitrous Oxide Inlet: Male DISS (CGA 1040)
Nitrous Oxide Mixed Ratio Range: 0 to 70%
Oxygen Flow Range: 1.0 to 10 LPM
Nitrous Oxide Flow Range: 0 to 7 LPM
Inlet Pressure (each gas): 50 to 55 psi
Resuscitator Connector: Quick Connect (.25 in Imperial)
Resuscitator Connector Flow: 100 LPM Oxygen





A **Accutron™ Ultra PC™ % Flowmeter**
31975



D **Mobile Stand**
32005
Height with Flowmeter:
35.75 in, W x D: 22 in x 22 in



G **16 in Bi-fold Wall Arm**
32001



B **4-Cylinder Portable System**
44000
Height with Flowmeter:
36.375 in, W x D: 22 in x 22 in



E **Adjustable Mobile Stand**
42005
Height with Flowmeter:
H: 19.5 in to 30 in
W x D: 22 in x 22 in



H **Telescoping Wall Arm**
32003
(Extends 12 in to 17 in)



C **Accutron™ ClearView™ Scavenging Circuit II (Standard)**
43003
Includes a complimentary sampling of single-use nasal masks.



F **9 in Wall Arm**
32002



I **Universal Cabinet Slide, Ultra PC™ % Flowmeters & Ultra DC™ Flowmeters**
32004

Flowmeter Only

31975	Accutron™ Ultra PC™ % Flowmeter <i>Includes A</i>	\$3,634.00
--------------	---	-------------------

Portable Systems

36100	TOP SELLER Accutron™ Ultra PC™ % Flowmeter Package B Accutron™ Ultra PC™ % Flowmeter, 4-Cylinder Portable System, Accutron™ ClearView™ Scavenging Circuit II <i>Includes A B C</i>	\$7,780.00
--------------	---	-------------------

Central Systems

36200	Accutron™ Ultra PC™ % Flowmeter Package C Accutron™ Ultra PC™ % Flowmeter, Mobile Stand, Accutron™ ClearView™ Scavenging Circuit II <i>Includes A C D</i>	\$5,056.00
36200-ADJS	Accutron™ Ultra PC™ % Flowmeter Package C ADJS Accutron™ Ultra PC™ % Flowmeter, Adjustable Mobile Stand – Short, Accutron™ ClearView™ Scavenger Circuit II <i>Includes A C E</i>	\$5,056.00
36300	Accutron™ Ultra PC™ % Flowmeter Package D Accutron™ Ultra PC™ % Flowmeter, 9-inch Wall Arm & Mounting, Adapter 24552, Accutron™ ClearView™ Scavenging Circuit II <i>Includes A C F</i>	\$5,056.00

36400	Accutron™ Ultra PC™ % Flowmeter Package E Accutron™ Ultra PC™ % Flowmeter, 16-inch Bi-fold Wall Arm & Mounting Adapter 24552, Accutron™ ClearView™ Scavenging Circuit II <i>Includes A C G</i>	\$5,056.00
36500	Accutron™ Ultra PC™ % Flowmeter Package F Accutron™ Ultra PC™ % Flowmeter, Telescoping Wall Arm & Mounting Adapter 24552, Accutron™ ClearView™ Scavenging Circuit II <i>Includes A C H</i>	\$5,056.00
36500-US	TOP SELLER Accutron™ Ultra PC™ % Flowmeter Package U Accutron™ Ultra PC™ % Flowmeter, Universal Cabinet Slide, PC /DC (slide mounts to left, right, or under cabinet), and Mounting Adapter 24552, Accutron™ ClearView™ Scavenging Circuit II <i>Includes A C I</i>	\$5,056.00

Order quick connect hoses for Packages C - U separately.



Accutron™ Ultra PC™ % Cabinet Mount, 36800-CHAIR Template

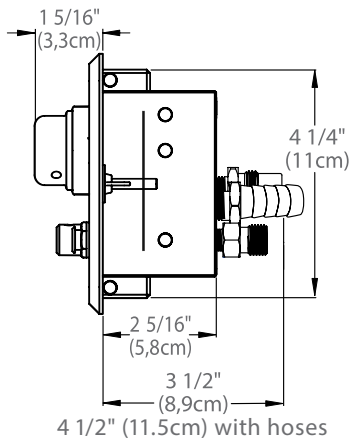
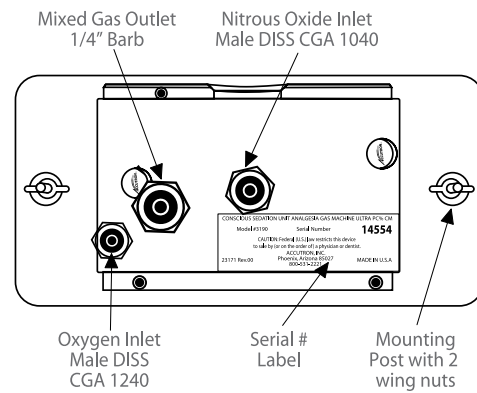
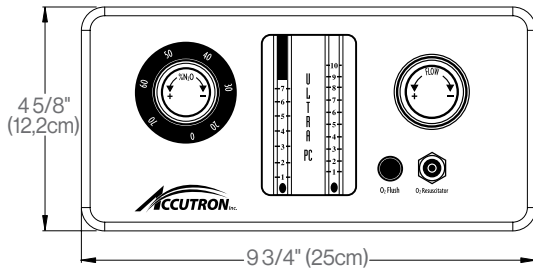
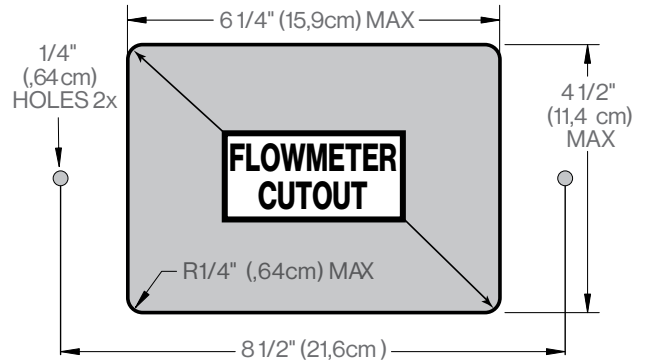

1) In advance of construction:

- a) Provide for tubing chase from flowmeter location to chair J-Box.
- b) Install Vacuum, Oxygen, and Nitrous Oxide risers.

2) Installation:

- a) Ensure cut-out for the flowmeter is located correctly.
- b) Mount Ultra PC™ Flowmeter through cutout, install wing nuts, and connect hoses to risers.
- c) Pull the Mixed Gas and Vacuum lines up to the Remote Flow System mounting location on the chair.
- d) Install Remote Flow System to chair. (Requires purchase of brand-specific Chairmount Kit).
- e) Complete connections of all hoses.



Accutron™ Ultra PC™ % Cabinet Mount Flowmeter Diagram



Diagram is specific to 36800 Ultra PC™ % Cabinet Mount Flowmeter with RFS™ Vacuum Controller.

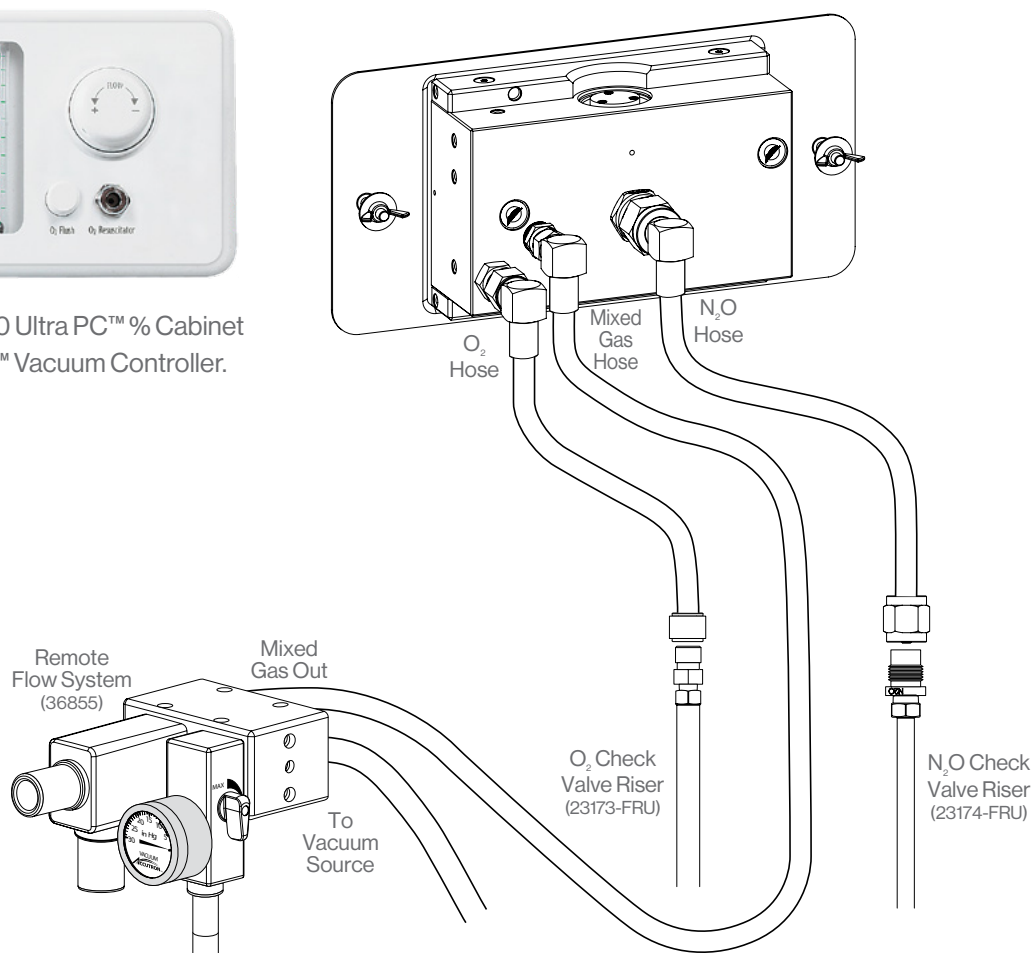

Accutron™ Ultra PC™ % Cabinet Mount Flowmeter Template

- Vertical dimension of cut is 4 1/2" MAX
- Horizontal dimension of cut is 6 1/4" MAX
- Minimum depth is 4 1/2" with hoses attached

Options for vacuum system controllers include:
Standard Bag Tee and RFS™ Remote Flow System.

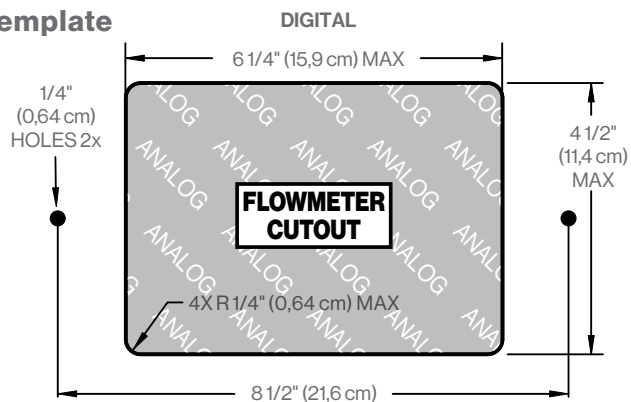

All templates are not to scale.



Accutron™ Ultra DC™ Flowmeter

Our Accutron™ Ultra DC™ Flowmeter features independent oxygen and nitrous oxide controls along with oxygen control with on/off switch, oxygen fail-safe, oxygen flush, oxygen resuscitation connector. This product also includes an emergency air valve, directional check valve and DISS inlet fittings.

Dimensions: 4.25 in x 10.5 in x 8 in (10.8 cm x 26.7 cm x 20.3 cm)
Weight: 4.5 lbs (00 kg)
Mixed Gas Outlet Diameter: .875 in Nominal (22mm)
Oxygen Inlet: Male DISS (CGA 1240)
Nitrous Oxide Inlet: Male DISS (CGA 1040)
Oxygen Flow Range: 3 to 10 LPM
Nitrous Oxide Flow Range: 0 to 7 LPM
Inlet Pressure (each gas): 50 to 55 psi
Resuscitator Connector: Quick Connect (.25 in Imperial)
Resuscitator Connector Flow: 100 LPM Oxygen





A



**Accutron™ Ultra DC™
Flowmeter**
31980

D



Mobile Stand
32005
Height with Flowmeter:
35.75 in, W x D: 22 in x 22 in

G



16 in Bi-fold Wall Arm
32001

B



4-Cylinder Portable System
Height with Flowmeter:
36.375 in, W x D: 22 in x 22 in

E



Adjustable Mobile Stand
42005
Height with Flowmeter:
H: 19.5 in to 30 in
W x D: 22 in x 22 in

H



Telescoping Wall Arm
32003
(Extends 12 in to 17 in)

C



**Accutron™ ClearView™
Scavenging Circuit II
(Standard)**
43003
Includes a complimentary
sampling of single-use
nasal masks.

F



9 in Wall Arm
32002

I



**Universal Cabinet Slide,
Ultra PC™ % Flowmeters
& Ultra DC™ Flowmeters**
32004

Flowmeter Only

31980	Accutron™ Ultra DC™ Flowmeter Includes A	\$2,664.00
--------------	---	-------------------

Portable Systems

46100	Accutron™ Ultra DC™ Flowmeter Package B Accutron™ Ultra DC™ % Flowmeter, 4-Cylinder Portable System, Accutron™ ClearView™ Scavenging Circuit II Includes A B C	\$6,966.00
--------------	--	-------------------

Central Systems

46200	Accutron™ Ultra DC™ Flowmeter Package C Accutron™ Ultra DC™ Flowmeter, Mobile Stand, Accutron™ ClearView™ Scavenging Circuit II Includes A C D	\$4,070.00
--------------	--	-------------------

46200-ADJS	Accutron™ Ultra DC™ Flowmeter Package C ADJS Accutron™ Ultra DC™ Flowmeter, Adjustable Mobile Stand – Short, Accutron™ ClearView™ Scavenger Circuit II Includes A C E	\$4,070.00
-------------------	---	-------------------

46300	Accutron™ Ultra DC™ Flowmeter Package D Accutron™ Ultra DC™ Flowmeter, 9-inch Wall Arm & Mounting, Adapter 24552, Accutron™ ClearView™ Scavenging Circuit II Includes A C F	\$4,070.00
--------------	--	-------------------

46400	Accutron™ Ultra DC™ Flowmeter Package E Accutron™ Ultra DC™ Flowmeter, 16-inch Bi-fold Wall Arm & Mounting Adapter 24552, Accutron™ ClearView™ Scavenging Circuit II Includes A C G	\$4,070.00
--------------	--	-------------------

46500	Accutron™ Ultra DC™ Flowmeter Package F Accutron™ Ultra DC™ Flowmeter, Telescoping Wall Arm & Mounting Adapter 24552, Accutron™ ClearView™ Scavenging Circuit II Includes A C H	\$4,070.00
--------------	--	-------------------

46500-US	Accutron™ Ultra DC™ Flowmeter Package U Accutron™ Ultra DC™ Flowmeter, Universal Cabinet Slide, DC/DC (slide mounts to left, right, or under cabinet), and Mounting Adapter 24552, Accutron™ ClearView™ Scavenging Circuit II Includes A C I	\$4,070.00
-----------------	--	-------------------

Order quick connect hoses for Packages C - U separately.



Oral Surgery Flowmeters & Accessories

We provide a wide range of Flowmeter and Flowmeter Accessories for Oral Surgery including Digital Ultra™ Flowmeters, Ultra PC™ % Flowmeters and Ultra DC™ Flowmeters.

Oral Surgery Flowmeter Systems



A Digital Ultra™ Flowmeter



D Accutron™ ClearView™ Scavenging Circuit II (Standard)
43003

Includes a complimentary sampling of single-use nasal masks.



G 9 in Wall Arm
32002



B Digital Ultra™ Flushmount Flowmeter



E 4-Cylinder Portable System
54000



H 16 in Wall Arm
32001



C Adult full facemask, Hanks elbow with pop-off, directional Y valve and corrugated tube
47000



F Mobile Stand
32005
Height with Flowmeter: 35.75 in
W x D: 22 in x 22 in



I Telescoping Wall Arm
32003
(Extends 12 in to 17 in)

Portable Packages

56100-OS	Digital Ultra™ Oral Surgery Flowmeter Pkg. B, 4-Cylinder Portable <i>(includes portable manifold) Height with Flowmeter: 36.375 in (92.4 cm) W x D: 22 in x 22 in (55.9 cm x 55.9 cm)</i> <i>Includes A C D E</i>	\$10,652.00
-----------------	--	--------------------

Central Packages

56200-OS	Digital Ultra™ Oral Surgery Flowmeter Pkg. C, Mobile Stand <i>Includes A C D F</i>	\$7,408.00	56500-OS	Digital Ultra™ Oral Surgery Flowmeter Pkg. F, Telescoping Wall Arm <i>Includes A C D I</i>	\$7,408.00
56200-OS-ADJT	Digital Ultra™ Oral Surgery Flowmeter Pkg. C, Adjustable Stand <i>Includes A C D</i>	\$7,408.00	56600-OS	Digital Ultra™ Oral Surgery Flowmeter Pkg. G, Flushmount <i>Includes B C D</i>	\$8,708.00
56300-OS	Digital Ultra™ Oral Surgery Flowmeter Pkg. D, 9 in. Wall Arm <i>Includes A C D G</i>	\$7,408.00	56800-OS	TOP SELLER Digital Ultra™ Oral Surgery Flowmeter Pkg. H, Flushmount with RFS™ Remote Flow <i>Includes B C D</i>	\$8,858.00
56400-OS	Digital Ultra™ Oral Surgery Flowmeter Pkg. E, 16 in. Bi-fold Wall Arm <i>Includes A C D H</i>	\$7,408.00			



Ultra PC™ % Oral Surgery Flowmeter Packages



A Ultra PC™ % Flowmeter
31975-OS



D Accutron™ ClearView™
Scavenging Circuit II
(Standard)
43003
*Includes a complimentary
sampling of single-use
nasal masks.*



G 9 in Wall Arm
32002

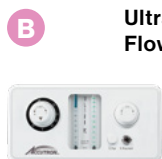

B Ultra PC™ % Cabinet Mount
Flowmeter



E 4-Cylinder Portable System
44000



H 16 in Bi-fold Wall Arm
32001



C Adult full facemask,
Hanks elbow with pop-off,
directional Y valve and
corrugated tube
47000



F Mobile Stand
32005
*Height with Flowmeter:
35.75 in, W x D: 22 in x 22 in*



I Telescoping Wall Arm
32003
(Extends 12 in to 17 in)



J Mobile Stand
32005-AT
*Height with Flowmeter:
35.75 in, W x D: 22 in x 22 in*

Portable Packages

36100-OS	Ultra PC™ % Oral Surgery Flowmeter Pkg. B 4-Cylinder Portable (includes portable manifold) Height with Flowmeter: 36.375 in (92.4 cm) W x D: 22 in x 22 in (55.9 cm x 55.9 cm) <i>Includes A C D E</i>	\$9,582.00
-----------------	---	-------------------

Central Packages

36200-OS	Ultra PC™ % Oral Surgery Flowmeter Pkg. C Mobile Stand Height with Flowmeter: 36.375 in (92.4 cm) W x D: 22 in x 22 in (55.9 cm x 55.9 cm) <i>Includes A C D F</i>	\$6,534.00	36400-OS	TOP SELLER Ultra PC™ % Oral Surgery Flowmeter Pkg. E 16 in Bi-fold Wall Arm <i>Includes A C D H</i>	\$6,534.00
36200-OS-ADJT	Ultra PC™ % Oral Surgery Flowmeter Pkg. C-ADJT Includes Adjustable Mobile Stand – Tall Height with Flowmeter: 39.375 in to 50.375 in (100 cm to 128 cm) W x D: 22 in x 22 in (55.9 cm x 55.9 cm) <i>Includes A C D J</i>	\$6,534.00	36500-OS	Ultra PC™ % Oral Surgery Flowmeter Pkg. F Telescoping Wall Arm <i>Includes A C D I</i>	\$6,534.00
36300-OS	Ultra PC™ % Oral Surgery Flowmeter Pkg. D 9 in Wall Arm <i>Includes A C D G</i>	\$6,534.00	36600-OS	Ultra PC™ % Oral Surgery Flowmeter Pkg. G Cabinet Mount <i>Includes B C D</i>	\$7,706.00



Ultra DC™ Oral Surgery Flowmeter Packages



A Ultra DC™ Flowmeter
31980-OS



D 4-Cylinder Portable System



G 16 in Bi-fold Wall Arm
32001



B Adult full facemask,
Hanks elbow with pop-off,
directional Y valve and
corrugated tube
47000

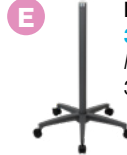

E Mobile Stand
32005
Height with Flowmeter:
35.75 in, W x D: 22 in x 22 in



H Telescoping Wall Arm
32003
(Extends 12 in to 17 in)



C Accutron™ ClearView™
Scavenging Circuit II
(Standard)
43003
*Includes a complimentary
sampling of single-use
nasal masks.*



F 9 in Wall Arm
32002

Portable Packages

46100-OS	Ultra DC™ Oral Surgery Flowmeter Pkg. B 4-Cylinder Portable (includes portable manifold) Height with Flowmeter: 39.375 in (100 cm) W x D: 22 in x 22 in (55.9 cm x 55.9 cm) <i>Includes A B C D</i>	\$8,470.00
-----------------	---	-------------------

Central Packages

46200-OS	Ultra DC™ Oral Surgery Flowmeter Pkg. C Mobile Stand Height with Flowmeter: 39.375 in (100 cm) W x D: 22 in x 22 in (55.9 cm x 55.9 cm) <i>Includes A B C E</i>	\$5,556.00
-----------------	--	-------------------

46200-OS-ADJT	Ultra DC™ Oral Surgery Flowmeter Pkg. C-ADJS Adjustable Mobile Stand – Tall Height with Flowmeter: 39.375 in to 50.375 in (100 cm to 128 cm) W x D: 22 in x 22 in (55.9 cm x 55.9 cm) <i>Includes A B C</i>	\$5,556.00
----------------------	---	-------------------









46300-OS	Ultra DC™ Oral Surgery Flowmeter Pkg. D 9 in Wall Arm <i>Includes A B C F</i>	\$5,556.00
-----------------	--	-------------------

46400-OS	Ultra DC™ Oral Surgery Flowmeter Pkg. E 16 in Bi-fold Wall Arm <i>Includes A B C G</i>	\$5,556.00
-----------------	---	-------------------

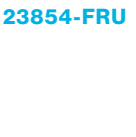





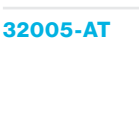
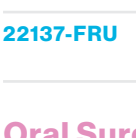

46500-OS	Ultra DC™ Oral Surgery Flowmeter Pkg. F Telescoping Wall Arm <i>Includes A B C H</i>	\$5,556.00
-----------------	---	-------------------

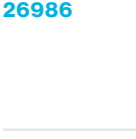

Oral Surgery Accessories

	47000 Oral Surgery Accessories Package \$1,442.00		33029-10 Pediatric Cannula with 7 ft Tubing (pkg. of 10) \$120.00
	23854-FRU Universal Female Adapter (22 mm male x 15 mm female) \$30.00		33030-10 Adult Cannula with 7 ft Tubing (pkg. of 10) \$120.00
	47050 Directional Y Valve \$896.00		38008 Full Facemask - Adult \$110.00
	47075 Hanks Elbow with Pop-off \$470.00		38009 Full Facemask - Child \$110.00
	33014 Corrugated Tube - 3 ft \$66.00		32005-AT Adjustable Mobile Stand - Tall H: 28.25 in to 40 in (71.6 cm to 101.6 cm) W x D: 22 in x 22 in (55.9 cm x 55.9 cm) \$666.00
	22137-FRU Corrugated Tube - 6 ft \$94.00		

Oral Surgery Suction Accessories

	34014 Surgical E-Vac Kit \$1,546.00 Includes: Vacuum Regulator, Five 1500 ml single-use canisters, wall mount plate and mounting hardware (vacuum outlet 34011 sold separately)		26988 Vacuum Regulator \$700.00
	34016 Replacement Canisters for Surgical E-Vac Kit \$132.00 Includes: Five 1500 ml single-use canisters		34017 Vacuum Regulator Mounting Bracket (for 26988) \$132.00 Regulator not included. Order 26988 separately.
	26986 6 ft Tubing - .375 in ID, Clear PVC \$58.00		26989 Vacuum Slide \$106.00
	26987 Canister Holder \$70.00		34011 Recessed Q/C Vacuum Outlet \$528.00 Requires use of Vacuum Male Connector 33972

Vacuum Controllers	32
RFS™ Remote Flow System Chairmount Kits	33
RFS™ Remote Flow System Chairmount Kits for Chair Brands	34
Clear Your Work Zone with a Chair Remote Flow System	37
Universal Cabinet Slide Mounts	38
Flowmeter Mounts & Stands	39

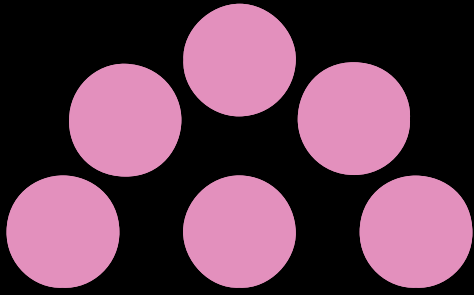

Vacuum Controllers & Mounts

Vacuum Controllers & Mounts replace the conventional bag tee and vacuum control valves that are part of the scavenging circuit. They can be installed remotely, and have different mounting options.



Vacuum Controllers

36855



RFS™ Remote Flow System – Analog
(for use with Ultra PC™ % Cabinet Mount Flowmeters, and Digital Ultra™ Flushmount Flowmeters with RFS™ Chairmount Kits)

\$1,280.00

56855



TOP SELLER

RFS™ Remote Flow System – Digital
(for use with Digital Ultra™ Flushmount without RFS™ Chairmount Kits)

\$1,282.00

56955



Accu-Vac™ Vacuum Controller
(for use with Digital Ultra™ Flushmount Flowmeter)

\$2,448.00

36855-CHAIR

36855-CHAIR Remote Flow System (RFS) Chairmount

\$1,316.00



RFS™ Remote Flow System Chairmount Kits

Our RFS™ Remote Flow System Chairmount Kits eliminate long mixed gas and vacuum hoses draping from adjacent cabinets, providing easier access for the doctor. They create uncluttered, safer work zone for doctor and staff and minimize displacement of patient mask caused by drag/pull and weight of long hoses.

RFS™ Remote Flow System Chairmount Kits store scavenging circuit and rubber goods when not in use. A wide variety of kits are available for compatibility with various chairs and mounts to patient chairs without drilling new holes and can be installed in the field whether retrofitted where possible or new construction.





RFS™ Remote Flow System Chairmount Kits for Chair Brands



A-dec

31005-1	A-dec Cascade (1040) RFS™ Chairmount Kit	\$418.00
31005-2	A-dec Decade (1021) & Decade + (1221) RFS™ Chairmount	\$418.00
31005-3	TOP SELLER A-dec 511 RFS™ Chairmount Kit	\$418.00
31005-4	A-dec 311 RFS™ Chairmount Kit (old style)	\$418.00
31005-4A	A-dec 300 series Chairmount Kit (new style)	\$418.00
31005-5	TOP SELLER A-dec 400 Series RFS™ Chairmount Kit	\$418.00
31005-6	A-dec Performer 8000 RFS™ Chairmount Kit	\$418.00



Boyd

31014-1	Boyd Oral Surgery S2600 Series RFS™ Chairmount Kit	\$418.00
----------------	--	-----------------

Brumaba

31016-1	Brumaba Oral Surgery OMS Series RFS™ Chairmount Kit	\$418.00
----------------	---	-----------------



Belmont

31006-4	Belmont Pro II, Chairmount Kit	\$414.00
31006-1	Belmont X-Calibur B20 RFS™ Chairmount Kit	\$414.00
31006-2	Belmont X-Calibur V B50 RFS™ Chairmount Kit	\$414.00
31006-3	Belmont Quolis and Evogue Q3300 RFS™ Chairmount Kit	\$414.00

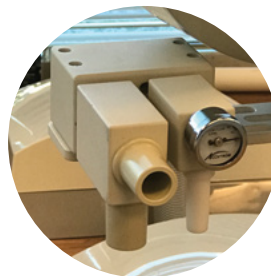

DCI

31013-1	TOP SELLER DCI Series 5 RFS™ Chairmount Kit	\$418.00
----------------	---	-----------------

Dansereau

31019-1	Dansereau Chairmount Kit	\$418.00
----------------	--------------------------	-----------------



DentalEZ

31009-1	DentalEZ Simplicity RFS™ Chairmount Kit	\$418.00
31009-2	DentalEZ NuSimplicity RFS™ Chairmount Kit	\$418.00
31009-3	DentalEZ J/V Generation RFS™ Chairmount Kit	\$418.00
31009-4	DentalEZ Core RFS™ Chairmount Kit	\$418.00



Forest

31001-1M	Forest 3900 (no extras, metric thread) RFS™ Chairmount Kit	\$418.00
31001-1S	Forest 3900 (no extras, standard thread), RFS™ Chairmount Kit	\$418.00
31001-2M	Forest 3900 (touch pad, metric thread) RFS™ Chairmount Kit	\$418.00
31001-2S	Forest 3900 (touch pad, standard thread) RFS™ Chairmount Kit	\$418.00
31001-3	Forest 3900 (assist pkg.) RFS™ Chairmount Kit	\$418.00
31001-4	Forest 3900 (touch pad & assist. Pkg.) RFS™ Chairmount Kit	\$418.00

Dexta

31018-1	Dexta Oral Surgery (20X-1, 20X-3, 25X, 9S, 52X02, 52X-3) RFS™ Chairmount Kit	\$418.00
----------------	--	-----------------

Engle

31008-1	Engle 300 RFS™ Chairmount Kit	\$418.00
----------------	-------------------------------	-----------------

Firstar

31009-4	Firstar FDC38 RFS™ Chairmount Kit	\$418.00
31022-1	Firstar FDC50 RFS Chairmount Kit <i>Coming Soon</i>	\$418.00



Marus

31004-1	Marus MaxStar (no extras) RFS™ Chairmount Kit	\$418.00
31004-3	Marus NuStar (no extras) RFS™ Chairmount Kit	\$418.00



Midmark

31002-1	Midmark Ultra RFS™ Chairmount Kit	\$418.00
31002-2	Midmark Elevance RFS™ Chairmount Kit	\$418.00
31002-3	Midmark 641 Surgery RFS™ Chairmount Kit	\$434.00



Pelton & Crane

31003-1	Pelton & Crane 1800 Series RFS™ Chairmount Kit	\$418.00
31003-2	Pelton & Crane 3000 Series RFS™ Chairmount Kit	\$418.00
31003-3	Pelton & Crane 1700 RFS™ Chairmount Kit	\$418.00



MTI

31017-1	MTI Oral Surgery 721 RFS™ Chairmount Kit	\$418.00
----------------	--	-----------------

Royal

31007-1	Royal Alliant RFS™ Chairmount Kit	\$418.00
31007-2	Royal Signet R16 RFS™ Chairmount Kit	\$418.00
31007-3	Royal PD2/OR2/OR3/GP2 (w/o light) RFS™ Chairmount Kit	\$418.00
31007-4	Royal PD2/OR2/OR3/GP2 (with light) RFS™ Chairmount Kit	\$418.00
31007-5	Royal Domain RFS™ Chairmount Kit	\$418.00
31007-6	Royal OS1 Oral Surgery RFS™ Chairmount Kit	\$418.00

OSSI

31010-1	OSSI Dino RFS™ Chairmount Kit	\$418.00
----------------	-------------------------------	-----------------

Sirona

31020-1	Sirona Teneo Chairmount Kit	\$418.00
31020-2	Sirona Intego Chairmount Kit	\$418.00

Pediatric Bench

31012-1	Pediatric Bench (standard) RFS™ Chairmount Kit	\$418.00
----------------	--	-----------------

Westar

31015-1	Westar Oral Surgery (OS VIII & OS III) RFS™ Chairmount Kit	\$418.00
----------------	--	-----------------



Clear Your Work Zone with a Chair Remote Flow System

Digital Ultra™ Flushmount Flowmeter Diagram

56800-CHAIR

56800-CHAIR-NS

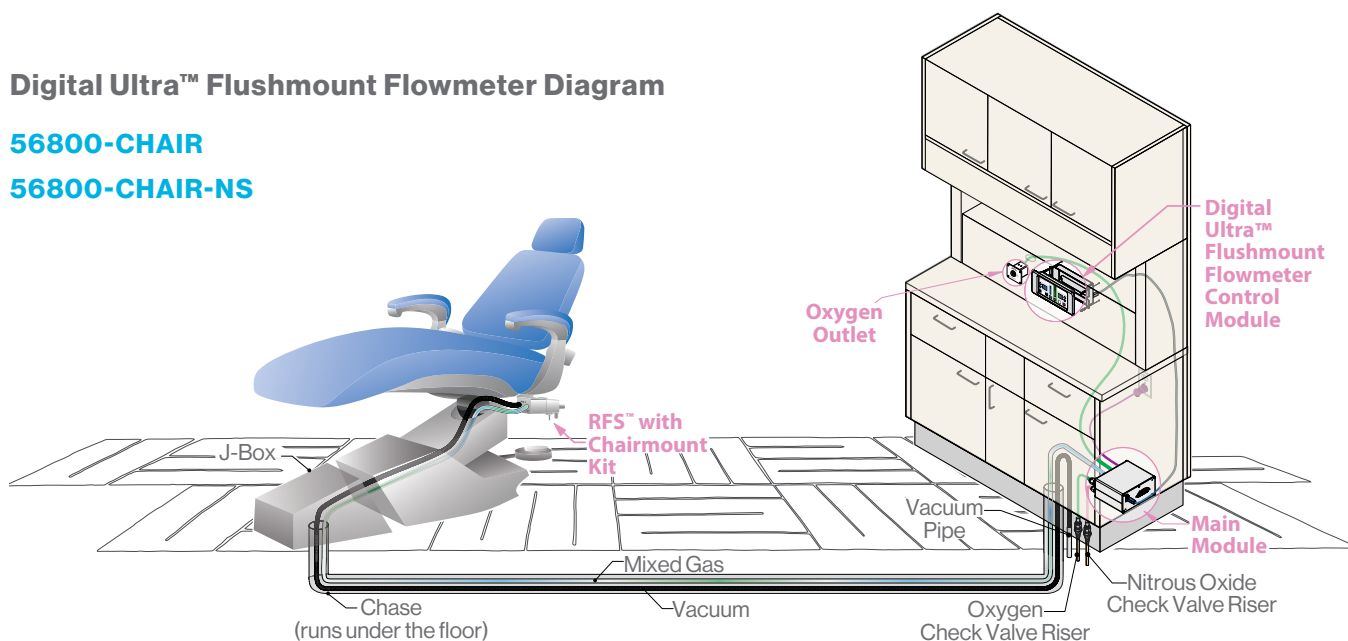

Ultra PC™ % Cabinet Mount Flowmeter Diagram

36800-CHAIR

36800-CHAIR-NS

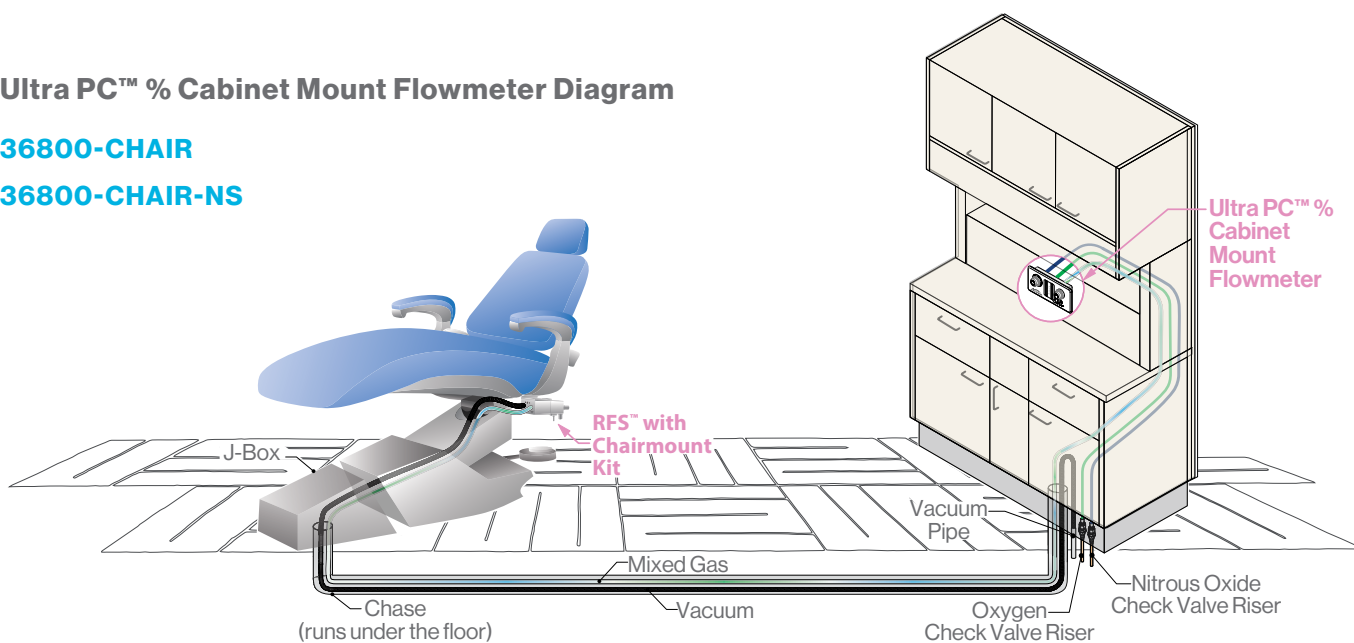



Universal Cabinet Slide Mounts

Accu-Vac™ and RFS™ Mounts (for Digital Ultra™ Flushmount Flowmeter)

32015 Universal Cabinet Slide, Accu-Vac™ Vacuum Controller **\$674.00**
 (slide mounts to left, right, or under cabinet)
Use with 56955 and 56950 flowmeter package



32018 **TOP SELLER** Universal Cabinet Slide, Digital RFS™ System **\$674.00**
 (slide mounts to left, right, or under cabinet)
Use with 56855 and 56800 flowmeter package



RFS™ Remote Flow System A Mounts (for Ultra PC™ % Cabinet Mount Flowmeter)

25043 Universal Light Pole Mount Kit **\$590.00**
 (not shown)

32014 Universal Cabinet Slide, Analog RFS™ System **\$654.00**
 (slide mounts to left, right, or under cabinet)
Use with 36855 and 36800 flowmeter package



Universal Slide Mount (for Ultra PC™ % Flowmeters & Ultra DC™ Flowmeters)

32004 Universal Cabinet Slide for Ultra™ PC/DC **\$674.00**
 with Mounting Adapter #24552 (slide mounts to left, right, or under cabinet)
Use with 31975, 31980 flowmeters



Analog Bag Tee Mount (for Ultra PC™ % Cabinet Mount Flowmeter)

32008 Universal Cabinet Slide, Analog Bag Tee **\$676.00**
 (slide mounts to left, right, or under cabinet)
Use with 26679-FRU and 36600 flowmeter package



Digital Bag Tee Mount (for Digital Ultra™ Flushmount Flowmeter)

32019 Universal Cabinet Slide, Digital Bag Tee **\$674.00**
 (slide mounts left, right, or under cabinet)
Use with 27187 and 56600 flowmeter package













Flowmeter Mounts & Stands

Flowmeter Mounts & Mounting Adapters

	32001 16 in Bi-fold Wall Arm & Mounting Adapter 24552	\$578.00
	32002 9 in Wall Arm & Mounting Adapter 24552	\$532.00
	32003 TOP SELLER Telescoping Wall Arm (extends 12 in to 17 in), and Mounting Adapter 24552	\$562.00
	32004 Universal Cabinet Slide for Ultra PC/DC (slide mounts to left, right, or under cabinet), includes Mounting Adapter 24552	\$674.00
	24552 Mounting Adapter for Ultra PC™ and Ultra DC™ Flowmeters	\$110.00
	32010 Portable and Mobile Stand Adapter – Digital Ultra™ Flowmeters, Ultra PC™ % Flowmeters, and Ultra DC™ Flowmeters to Porter™ Flowmeter	\$104.00

Mobile Stands & Components

	20107-FRU E Cylinder Wrench	\$38.00
	24494 TOP SELLER Replacement E Washers (pkg. of 10)	\$42.00
	24549 E Yoke Handle	\$58.00
	32010 Portable and Mobile Stand Adapter Accutron™ Digital Ultra™ Flowmeters, Ultra PC™ % Flowmeters and Ultra DC™ Flowmeters to Porter™ Flowmeter	\$104.00

	32005 Mobile Stand H: 31.5 in (80 cm) W x D: 22 in x 22 in (55.9 cm x 55.9 cm)	\$574.00
	32021 Wall bracket with mounting post for the Ultra PC™ Flowmeters and Ultra DC™ Flowmeters	\$290.00
	32055 Surface Mount for Digital Ultra™ Flushmount (flowmeter not included)	\$482.00
	42005 Adjustable Mobile Stand – Short H: 19.5 in to 30 in (49.5 cm to 76.2 in) W x D: 22 in x 22 in (55.9 cm x 55.9 cm)	\$686.00
	32011 Wall Arm Adapter – Ultra PC and Ultra DC to Matrix™ Wall Arms	\$104.00

	44000 TOP SELLER 4-Cylinder Non-Digital Mobile Stand	\$3,956.00
	54000 4-Cylinder Digital Stand	\$3,688.00

Accutron™ Digi-Flo™ Digital Automatic Switching Manifold Systems	42
Accutron™ Guardian Monitor™ Manifold/Alarm System	44

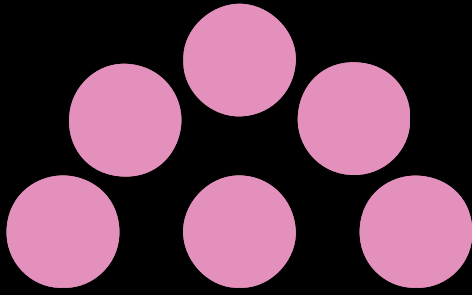

Manifold Systems

Our wide variety of Manifold Systems and accessories are designed to safely and economically deliver nitrous oxide and oxygen to dental operatories.



Accutron™ Digi-Flo™ Digital Automatic Switching Manifold Systems

Our Digital Automatic Manifold/Alarm System features an automatic cylinder changeover. Its alarm includes both audio and visual warnings. Designed to safely and precisely provide uninterrupted gas supply to the dental operator. With easily accessible components, our Digital Automatic Manifold/Alarm System allows for dual alarm panels and up to four zone valves. Includes pre-install mounting bracket allowing for effortless installation.

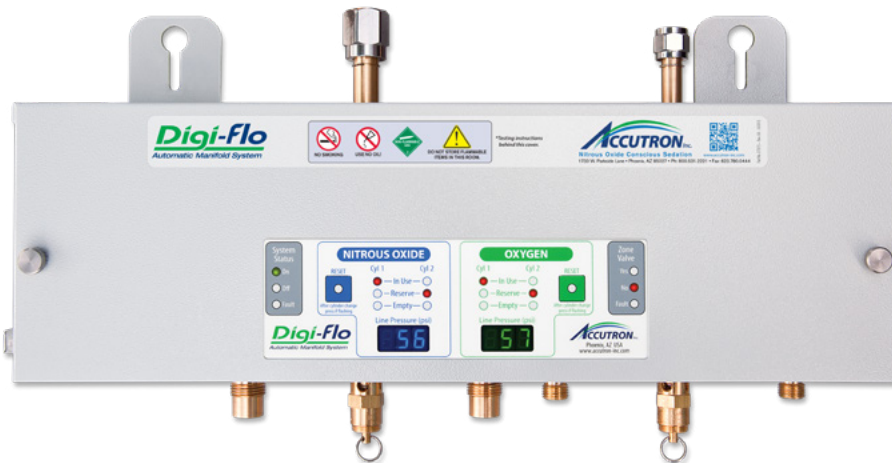

Manifold Package Contents:

Manifold with pressure gauges and high/low pressure alarm switches, 4 cylinder regulators (2 O₂ and 2 N₂O), four 4 ft DISS hoses (2 O₂ and 2 N₂O), power supply, wall control panel and cylinder restraints.

Dimensions with Cover: 18 in x 9 in x 3 in (45.7 cm x 22.9 cm x 7.6 cm)

Working Pressure: 50 to 55 psi

Hose Length: 4 ft

N2O Outlet: N2O DISS

O2 Outlet: O2 DISS

Primary Voltage: 120 volts

Cable: Category 6, Shielded, Ethernet 4 twisted pr.



Zone Valve (49550) required at installation as per NFPA 2021.

• **Order 27497-FRU for the Digi-Flo Manifold without accessories.**



Download Template and Specifications for Flowmeter and Outlet Installations.



Accutron™ Digi-Flo™ Automatic Manifolds with Wall Alarms

49250	TOP SELLER Digi-Flo™ Automatic Switching Manifold/Alarm Pkg. B Wall Alarm Panel (includes pre-install kit)	\$7,600.00	49450	Digi-Flo™ Automatic Switching Manifold/Alarm Pkg. D Wall Alarm Panel & Security System (includes pre-install kit)	\$8,480.00
49250-NP	TOP SELLER Manifold with Wall Alarm Panel Pkg. B (Without pre-install kit)	\$7,280.00	49450-NP	Manifold with Wall Alarm Panel & Security System Pkg. D (without pre-install kit)	\$8,160.00

Accutron™ Digi-Flo™ Automatic Manifold Zone Valves, Pre-Install Kits and Alarms

27535	Digi-Flo™ Wall Alarm	\$890.00	49054	Digi-Flo™ 2nd Wall Alarm (includes splitter P/ N 27972 for 2nd alarm)	\$1,004.00
49052	TOP SELLER Pre-installation Kit for Digi-Flo™ Automatic Manifold Pkgs. B & D Contents: Manifold template, manifold Mounting plate assembly with brass risers, 100 ft. cable, outlet box and mounting bracket for wall alarm panel	\$320.00	49054-S	Digi-Flo™ 2nd Wall Alarm with Security System (includes splitter P/ N 27972 for 2nd alarm)	\$1,030.00
49053	Pre-Install Kit for Digi-Flo™ 2nd Wall Alarm	\$174.00	49550	TOP SELLER Digi-Flo™ Zone Valve	\$2,058.00
			49650	Source Valve Kit (includes 2 valves)	\$496.00

Digi-Flo™ Automatic Manifold Accessories & Adapters

27985-FRU	Digi-Flo™ Optional Conduit Kit	\$356.00	28408-FRU	Belmed Manifold Adapter Kit	\$192.00
28191-FRU	Oxygen Add-on Dual Regulator Kit	\$1,884.00	28401-FRU	Accutron™ (Old Style) Manifold Adapter Kit	\$236.00
27954-FRU	Matrx™ Manifold Adapter Kit	\$192.00	49400	Zone Valve Adapter Box – Converts Normally Open (NO) switches on Zone Valves to Digi-Flo™ Manifold <i>Use with Accutron Guardian™ Accutron Guardian II, Ohmeda Centurion II, Matrx Flo-Safe, Porter Vanguard II Zone Valves</i>	\$982.00
28406-FRU	Porter™ Manifold Adapter Kit	\$230.00	49400-NC	Zone Valve Adapter Box – Converts Normally Closed (NC) switches on Zone Valves to Digi-Flo™ Manifold	\$866.00
28389-FRU	Digi-Flo N ₂ O and O ₂ Brazed Risers	\$190.00			



Accutron™ Guardian Monitor™ Manifold/Alarm System

Our Guardian Monitor™ Manifold and Alarm System includes a manual cylinder changeover and pressure relief valve. Alarm features audio and visual warnings. This Manifold System accommodates G and H cylinders. Zone valve package is available.



Manifold Package 38002, 38002-NP, 38003, 38003-NP, 38004, 38004-NP, 38005, and 38005-NP contain:
Manifold with pressure gauges and high/low pressure alarm switches, 3 or 4 cylinder regulators (2 O₂ and 1 or 2 N₂O), three or four 4 ft DISS hoses (2 O₂ and 1 or 2 N₂O), power supply, wall or desk office control panel and cylinder restraints.

Accutron™ Guardian Monitor™ Manifold for Wall Alarms











38002	TOP SELLER	\$5,742.00	38004-NP	Guardian Monitor™ Conventional Manifold/Wall Alarm System C 2 O ₂ + 1 N ₂ O (without pre-install kit)	\$4,980.00
38002-NP	TOP SELLER	\$5,554.00	39550	Guardian Monitor™ Zone Valve (for Guardian Monitor™ Conventional Manifold)	\$1,882.00
38004		\$5,166.00	49650	Source Valve Kit (includes 2 valves)	\$496.00

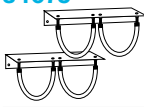

Accutron™ Guardian Monitor™ Manifold with Desk Alarms

38003	Guardian Monitor™ Conventional Manifold/Desk Alarm System B O ₂ + 2 N ₂ O (includes pre-install kit)	\$5,742.00	38005	Guardian Monitor™ Conventional Manifold/Desk Alarm System D 2 O ₂ + 1 N ₂ O (includes pre-install kit)	\$5,166.00
38003-NP	Guardian Monitor™ Conventional Manifold/Desk Alarm System B O ₂ + 2 N ₂ O (without pre-install kit)	\$5,554.00	38005-NP	Guardian Monitor™ Conventional Manifold/Desk Alarm System D 2 O ₂ + 1 N ₂ O (without pre-install kit)	\$4,980.00

Manifold Accessories & Components

26053-FRU	Zone Valve Box Trim/Frame Assembly (for Zone Valve #49550)	\$380.00	34062	 Nitrous Oxide Hose (DISS 3 feet)	\$168.00
23126	 Gas Identification Labels (6 O ₂ and 6 N ₂ O)	\$50.00	48075	 Nitrogen Regulator	\$610.00
23148	 100 ft. CAT6 Black Cable and Connector	\$146.00	48078	 Nitrogen Hose DISS (DISS 3 feet)	\$184.00
27224-FRU	Cylinder Room Caution Sticker	\$12.00	34075	 Cylinder Restraints (accommodates 4 cylinders)	\$314.00
27319	 Purge Fitting Set	\$114.00	48025	Cylinder Restraints (accommodates 2 cylinders)	\$190.00
34057	 Oxygen Regulator	\$552.00	25340	Guardian Power Supply	\$50.00
34061	 Oxygen Hose (DISS 3 feet)	\$168.00	22749-FRU	Guardian & Guardian II Power Supply	\$50.00
34058	 Nitrous Oxide Regulator	\$552.00	38052	 Pre-installation Kit for Guardian™ Manifold Packages A & C Wall Alarm Includes manifold template, manifold mounting plate assembly with brass risers, 100 ft. cable, outlet box and mounting bracket for wall alarm panel	\$188.00

Nitrogen and Oxygen Manifolds

48000	Nitrogen Manifold System Includes: Manifold, Regulator, 3' Hose, Tank Restraints	\$3,792.00	49000	Oxygen Manifold System Includes: Manifold, Regulator, 3' Hose, Tank Restraints	\$3,792.00
48020	Nitrogen Manifold Manifold only	\$1,236.00	49020	Oxygen Manifold Manifold only	\$1,236.00



Central Schematic Diagram

Mains and branches in piping systems shall be not less than 1/2" nominal size.

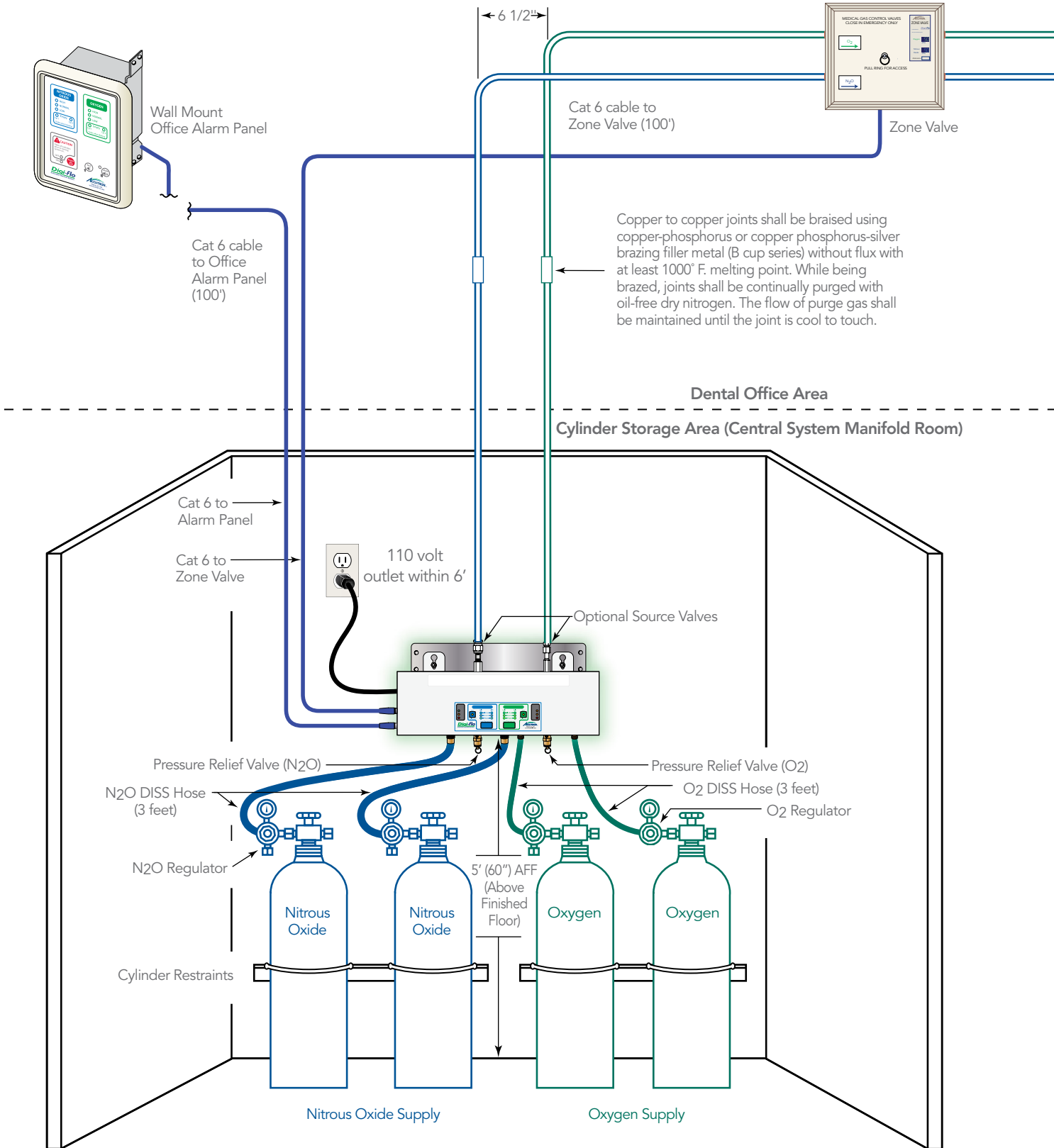

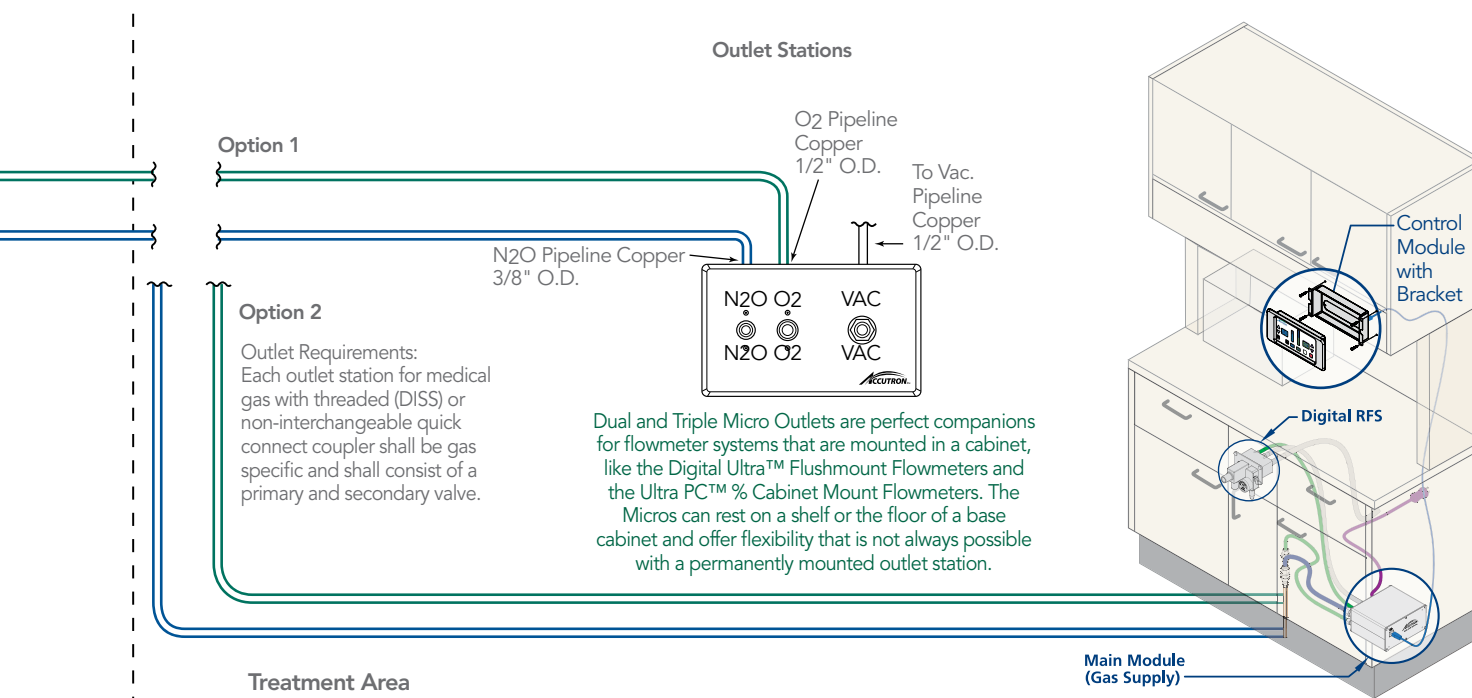

Medical Gas systems must be installed by a licensed medical gas installer (i.e. ASSE 6010) and be verified by a licensed medical gas verifier (i.e. ASSE 6030) and must be installed in compliance with NFPA 99 requirements.

Cylinder Storage Room Requirements:

No more than 3000 cubic feet of gas connected and in storage at one time (excluding nitrogen). Cylinders should be stored in a locked room or cabinet.

- A separate regulator for each gas cylinder
- A pressure relief valve set at 75 psi
- A check valve down stream of each regulator
- System line pressure set at 50 psi
- When the supply system is remote, the switchover shall be automatic

Flexible tubing must not go through wall(s) or partition(s) and have a minimum burst pressure of 1000 psi. When nonflammable gas supply (N₂O-O₂) cylinders are located inside building, they should be in a separate room or enclosure, and separated from the rest of the building by not less than one-hour fire-resistant construction. Two vents of not less than 72 square inches in area should be included. One vent within 6 inches of the floor and one vent within 6 inches of the ceiling.

Exception: When an exterior wall cannot be provided see code for requirements. Openings between room or enclosure and interior shall be self-closing smoke and draft control, having a fire protection rating of not less than one hour.

General Piping Requirements:

Tubes, valves, fittings, outlet stations and other piping components in medical gas systems shall have been cleaned for oxygen service prior to installation. Piping shall be hard-drawn seamless medical gas tube, type K or L (ASTM B819), and bear one of the following markings: OXY, MED, OXY/MED, ACR/OXY or ACR/MED. Piping for non-flammable medical gas systems shall be suitable for oxygen service. Each length of tube shall be permanently labeled and delivered plugged and capped. Fittings, valves and other devices shall be sealed and marked. The installer shall furnish documentation certifying that all installed piping materials comply with the requirements and that the plumber has the appropriate medical gas license.

Testing Requirements:

Piping Integrity and System Verification Final Testing include:

- Initial Pressure Test
- Blow Down
- Piping Purge
- Static Pressure Test
- Pressure Relief Test
- Cross Connection Test
- Alarm Testing for Gas System

Refer to NFPA 99. The responsible facility authority will review all inspection and testing prior to the use of all systems covered by this requirement.

Note: At the time of this printing, NFPA 2005, 2012, 2015, and 2018 are in use in North America. It is important to consult with your local municipality to confirm which codes(s) they have currently adapted.

Hoses & Connectors	50
Recessed, Surface & Micro Outlet Stations	54

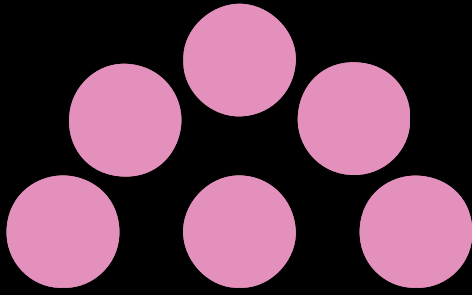

Hoses, Connectors & Outlet Stations

We offer a complete line of quick-connect hoses and connectors that are compatible with a wide variety of outlet stations. Our many options of Outlet Stations are available for Central Systems - connecting your flowmeter in each operatory to your gas supply in another area of your office.



Hoses & Connectors

We carry a complete line of quick-connect hoses and connectors that are compatible with a wide variety of outlet stations.

Hose Ends



Accutron™ E-Z
Q/C



Schrader
In-Line Q/C



Oxyquip
Q/C



or
DISS
Hand-Tight



Chemtron Q/C



Schrader
wFlush Q/C



Puritan Bennett
Q/C



DISS 90°



Matrix/Ohio
Q/C



DISS

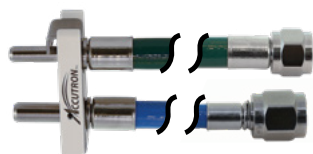

33968

Accutron™ EZ QC Hose Set

33968-2	2 ft.	\$332.00
33968-3	3 ft.	\$334.00
33968-4	4 ft.	\$336.00
33968-5	5 ft.	\$338.00
33968-6	6 ft.	\$340.00
33968-8	8 ft.	\$342.00
33968-10	10 ft.	\$344.00

O₂ MQC x DISS Hose

33969	3 ft.	\$340.00
33969-5	5 ft.	\$336.00
33969-6	6 ft.	\$338.00
33969-10	10 ft.	\$340.00



34061-90HT

O₂ DISS Hand Tight x DISS 90 Deg Hose

34061-90HT-3	3 ft.	\$216.00
34061-90HT-5	5 ft.	\$218.00
34061-90HT-6	6 ft.	\$220.00
34061-90HT-8	8 ft.	\$222.00
34061-90HT-10	10 ft.	\$224.00



33968-90

Accutron™ 90 Deg EZ QC Hose Set

33968-90-3	3 ft.	\$356.00
33968-90-4	4 ft.	\$358.00
33968-90-5	5 ft.	\$360.00
33968-90-6	6 ft.	\$362.00
33968-90-8	8 ft.	\$364.00
33968-90-10	10 ft.	\$366.00



34061

O₂ Hose Assembly

34061	3 ft.	\$168.00
34061-5	5 ft.	\$170.00
34061-6	6 ft.	\$174.00
34061-8	8 ft.	\$176.00
34061-9	9 ft.	\$178.00
34061-10	10 ft.	\$180.00
34061-15	15 ft.	\$184.00



34061-HT

O₂ DISS x DISS Hand Tight Hose

34061-HT-3	3 ft.	\$196.00
34061-HT-5	5 ft.	\$198.00
34061-HT-6	6 ft.	\$200.00
34061-HT-8	8 ft.	\$202.00
34061-HT-10	10 ft.	\$204.00



34061-90

O₂ DISS x DISS 90 Deg Hose

34061-90-3	3 ft.	\$188.00
34061-90-5	5 ft.	\$190.00
34061-90-6	6 ft.	\$192.00
34061-90-8	8 ft.	\$194.00
34061-90-10	10 ft.	\$196.00

Accutron Connectors

33972	Accutron™ Vacuum Male Connector	\$192.00
33973	Scavenger Control, Outlet Mount	\$438.00



34062

N₂O Hose Assembly

34062	3 ft.	\$168.00
34062-5	5 ft.	\$170.00
34062-6	6 ft.	\$174.00
34062-8	8 ft.	\$176.00
34062-9	9 ft.	\$178.00
34062-10	10 ft.	\$180.00
34062-15	15 ft.	\$184.00



34070

PB O₂ Q/C Hose

34070	3 ft.	\$168.00
34070-5	5 ft.	\$170.00
34070-6	6 ft.	\$174.00
34070-8	8 ft.	\$176.00
34070-10	10 ft.	\$178.00



34072

OxyQuip O₂ Q/C Hose

34072	3 ft.	\$168.00
34072-5	5 ft.	\$170.00
34072-6	6 ft.	\$174.00
34072-8	8 ft.	\$176.00
34072-10	10 ft.	\$178.00



34062-90

N₂O DISS x DISS 90 Deg Hose

34062-90-3	3 ft.	\$188.00
34062-90-5	5 ft.	\$190.00
34062-90-6	6 ft.	\$192.00
34062-90-8	8 ft.	\$194.00
34062-90-10	10 ft.	\$196.00



34071

PB N₂O Q/C Hose

34071	3 ft.	\$168.00
34071-5	5 ft.	\$170.00
34071-6	6 ft.	\$174.00
34071-8	8 ft.	\$176.00
34071-10	10 ft.	\$178.00



34073

Oxyquip N₂O Q/C Hose

34073	3 ft.	\$168.00
34073-5	5 ft.	\$170.00
34073-6	6 ft.	\$174.00
34073-8	8 ft.	\$176.00
34073-10	10 ft.	\$178.00



34062-90HT

N₂O DISS HT x DISS 90 Deg Hose

34062-90HT-3	3 ft.	\$216.00
34062-90HT-5	5 ft.	\$218.00
34062-90HT-6	6 ft.	\$220.00
34062-90HT-8	8 ft.	\$222.00
34062-90HT-10	10 ft.	\$224.00

Puritan Bennett Connectors

34081	Puritan Bennett Vacuum Male Connector	\$166.00
33976	Puritan Bennett WAGD Male Connector	\$168.00

OxyQuip N₂O/O₂ Q/C Hose

34168-3	3 ft.	\$312.00
34168-4	4 ft.	\$314.00
34168-5	5 ft.	\$316.00
34168-6	6 ft.	\$318.00



34062-HT

N₂O DISS x DISS HT Hose

34062-HT-3	3 ft.	\$194.00
34062-HT-5	5 ft.	\$198.00
34062-HT-6	6 ft.	\$200.00
34062-HT-8	8 ft.	\$202.00
34062-HT-10	10 ft.	\$204.00

N₂O/O₂ PB Male Hose Set

34068-3	3 ft.	\$312.00
34068-4	4 ft.	\$314.00
34068-5	5 ft.	\$316.00
34068-6	6 ft.	\$318.00

Oxyquip Connectors

34084	Oxyquip Vacuum Male Connector	\$166.00
33977	Oxyquip WAGD Male Connector	\$250.00



34074

Matrx™ O₂ Q/C Hose

34074	3 ft.	\$168.00
34074-5	5 ft.	\$170.00
34074-6	6 ft.	\$174.00
34074-8	8 ft.	\$176.00
34074-10	10 ft.	\$178.00



34085

Chemtron O₂ Hose

34085	3 ft.	\$168.00
34085-5	5 ft.	\$170.00
34085-6	6 ft.	\$174.00
34085-8	8 ft.	\$176.00
34085-10	10 ft.	\$178.00



34087

Matrx™ N₂O Q/C Hose

34087	3 ft.	\$168.00
34087-5	5 ft.	\$170.00
34087-6	6 ft.	\$174.00
34087-8	8 ft.	\$176.00
34087-10	10 ft.	\$178.00



34086

Chemtron N₂O Hose

34086	3 ft.	\$168.00
34086-5	5 ft.	\$170.00
34086-6	6 ft.	\$174.00
34086-8	8 ft.	\$176.00
34086-10	10 ft.	\$178.00

Schrader Flush Q/C Hose

34668-3	3 ft.	\$312.00
34668-4	4 ft.	\$314.00
34668-5	5 ft.	\$316.00
34668-6	6 ft.	\$318.00

Matrx™ N₂O/O₂ Hose

34368-3	3 ft.	\$312.00
34368-4	4 ft.	\$314.00
34368-5	5 ft.	\$316.00
34368-6	6 ft.	\$318.00

Chemtron N₂O/O₂ Hose

34268-3	3 ft.	\$312.00
34268-4	4 ft.	\$314.00
34268-5	5 ft.	\$316.00
34268-6	6 ft.	\$318.00



33972

Matrx™ Connectors

34080	Matrx Vacuum Male Connector	\$166.00
33978	Matrx WAGD Male Connector	\$168.00

Chemtron Connectors

33979	Chemtron WAGD Male Connector	\$168.00
--------------	------------------------------	-----------------

Additional Connectors and Adapters

33972	Accutron™ Vacuum Male Connector	\$192.00
33974	Vacuum DISS Hand-Twist x 90° ½" Hose	\$168.00
33975	WAGD DISS Hand-Twist x 90° ½" Hose	\$168.00
35005	N ₂ Hand-Tight 90° x Schrader Female Q/C	\$282.00



Recessed, Surface & Micro Outlet Stations

Recessed Outlet Stations

34004	TOP SELLER Recessed Q/C Triple Outlet (N ₂ O-O ₂ -Vac)*	\$936.00	34011	Recessed Q/C Vacuum Outlet*	\$528.00
	34005 Recessed Q/C Dual Outlet (N ₂ O-O ₂)	\$604.00		34010-I Recessed Imperial Q/C N ₂ Outlet	\$770.00
	34009	Recessed Q/C O ₂ Outlet	\$528.00		34010-S Recessed Schrader Q/C N ₂ Outlet
			\$786.00		

Recessed Outlet Station Template

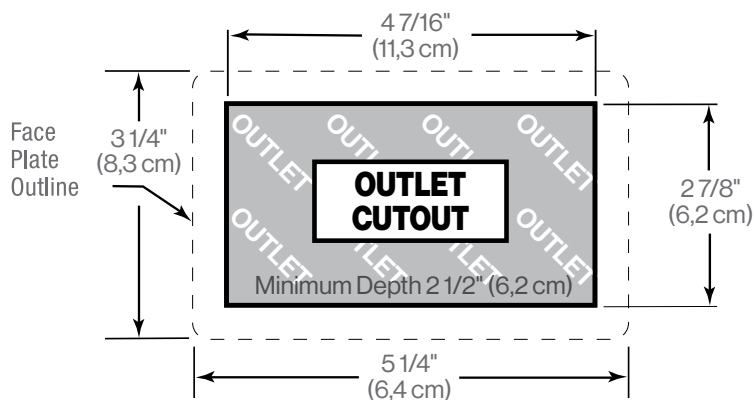



Surface Outlet Stations

34003 Floor Q/C Dual Outlet (N₂O-O₂) **\$1,080.00**



34079 Surface Q/C Vacuum Outlet* **\$568.00**



34060 Surface Q/C Triple Outlet (N₂O-O₂-Vac)* **\$1,044.00**



34078-I Surface Imperial Q/C N₂ Outlet **\$838.00**



34076 Surface Q/C Dual Outlet (N₂O-O₂) **\$696.00**



34078-S Surface Schrader Q/C N₂ Outlet **\$854.00**



34077 Surface Q/C O₂ Outlet **\$568.00**



Micro Outlet Stations

34012-3 **TOP SELLER** **\$1,354.00**



Micro In-line Triple Outlet Kit – DISS
(includes Check Valve Risers, hoses and outlet station)

34013-3-NS **Micro In-line Dual Outlet Kit – DISS** **\$694.00**



(for mounting within cabinetry; hoses included, risers sold separately)

34012-3-NS **Micro In-line Triple Outlet – DISS** **\$1,012.00**



(for mounting within cabinetry; hoses included, risers sold separately)*

27793-FRU **Oxygen Outlet – DISS with Female Q/C** **\$390.00**



(for use with Digital Ultra RFS™ Chairmount Kits)

34013-3 **Micro In-line Dual Outlet Kit – DISS** **\$1,042.00**



(includes Check Valve Risers, hoses and outlet station)

28000 **Micro Outlet Spacer** **\$76.00**



Micro In-Line Triple Outlet Template

Order Nos. **34012-3, 34012-3-NS**

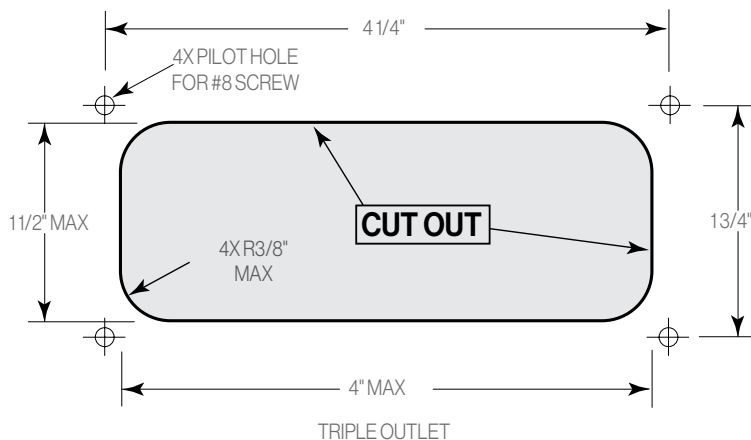

Micro In-Line Dual Outlet Template

Order Nos. **34013-3, 34013-3-NS**

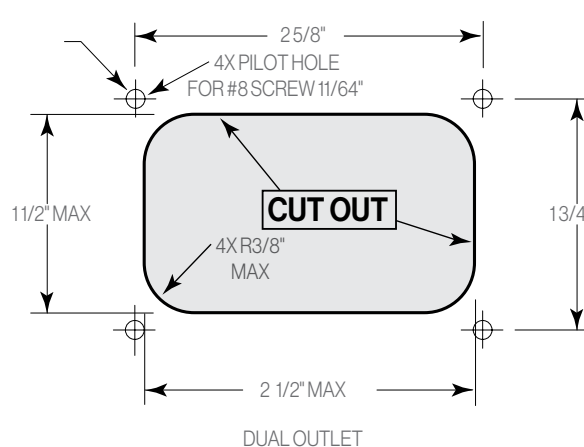

*Requires use of Vacuum Male Connector #33972.

Accutron™ Axess™ Low Profile Nasal Masks	58
Accutron™ ClearView™ Single-Use Nasal Masks	59
Accutron™ PIP+™ Nasal Masks	60
Capnography Adapters & Bundles	62
Accutron™ Axess™ Capnography Adapters	62
Accutron™ ClearView™ Capnography Adapters	63

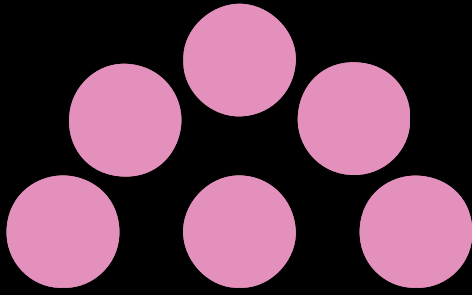

Nasal Masks

We offer four different types of Nasal Masks, in addition to capnography solutions, so you are sure to find a delivery solution that fits your practice. Since introducing our original Accutron™ Personal Inhaler Plus+™ Mask (PIP+) Nasal Mask design, dentistry has evolved and so have we. Our popular mask-in-mask Accutron™ ClearView™ Nasal Mask design and low profile Accutron™ Axess™ Nasal Mask design provide sleek, comfortable options for patients with helpful features for clinicians, as well. And with the American Dental Association's recommendation for single-use masks, we are the only manufacturer with three different types to choose from.



Accutron™ Axess™ Low Profile Nasal Masks



The low profile design of our Accutron™ Axess™ Low Profile Nasal Masks provide unencumbered access to the oral cavity. They fit snugly without tape or uncomfortable tubes protruding into the patient’s nostril. Accutron™ Axess™ Nasal Masks include lightweight, autoclavable scavenging circuit that minimize drag and pull, enhancing patient comfort. Available in scented and unscented options. Their translucent design allows for visual monitoring of patient’s breathing.

Accutron™ Axess™ Nasal Masks are individually wrapped for greater infection protection, and single-use to minimize cross-contamination. These Nasal Masks are not made with natural rubber latex.

Accutron™ Axess™ Low Profile Nasal Mask (24/box)

53037-9	Small Clear Unscented	\$182.00	53035-16	Medium Fresh Mint	\$182.00
53037-12	TOP SELLER Small Birthday Bubblegum	\$182.00	53034-9	Large Clear Unscented	\$182.00
53037-16	Small Fresh Mint	\$182.00	53034-12	Large Birthday Bubblegum	\$182.00
53035-9	TOP SELLER Medium Clear Unscented	\$182.00	53034-16	Large Fresh Mint	\$182.00
53035-12	Medium Birthday Bubblegum	\$182.00			



Accutron™ ClearView™ Single-Use Nasal Masks



The mask-in-mask design of our Accutron™ ClearView™ Single-Use Nasal Masks minimize ambient nitrous oxide in operatory and provide a clear outer mask, allowing visual monitoring of patient's breathing. A soft inner mask creates improved facial seal. The low profile of these Nasal Masks expand clinical field of view. Appealing colors and scents engage and relax patients.

Accutron™ ClearView™ Single-Use Nasal Masks are single-use, minimizing cross-contamination and are compatible with other scavenging circuits, including PIP+™ Scavenging Circuits. Not made with natural rubber latex.

Accutron™ ClearView™ Classic Nasal Mask (12/box)

33037-9	Pediatric Unscented Grey	\$97.00	33035-12	Adult Birthday Bubblegum	\$97.00
33037-10	Pediatric Outlaw Orange	\$97.00	33035-14	TOP SELLER Adult French Vanilla	\$97.00
33037-11	Pediatric Sassy Strawberry	\$97.00	33035-16	Adult Fresh Mint	\$97.00
33037-12	TOP SELLER Pediatric Birthday Bubblegum	\$97.00	33034-9	Large Adult Unscented Grey	\$97.00
33037-17	Pediatric Groovy Grape	\$97.00	33034-10	Large Adult Outlaw Orange	\$97.00
33035-9	Adult Unscented Grey	\$97.00	33034-14	Large Adult French Vanilla	\$97.00
33035-10	Adult Outlaw Orange	\$97.00	33034-16	Large Adult Fresh Mint	\$97.00

Accutron™ ClearView™ Nasal Masks connect effortlessly to:
 ClearView™ Scavenging Circuits I (**43005** and **43006**)
 ClearView™ Scavenging Circuit II (**43003** and **43004**)
 Any existing PIP+ Scavenging Circuit
 Any Porter™ Brown Scavenging Circuit (no adaptor required)
 Matrix Scavenging System (has one smooth tube on each side and comes with two connections) requires adapter SKU **35360**, **\$92.00**



Accutron™ PIP+™ Nasal Masks

Our Accutron™ PIP+™ Nasal Masks set the standard when it comes to conscious sedation therapy. These Nasal Masks provide patients with reliable and comfortable nitrous oxide/oxygen delivery and are single-use, minimizing cross-contamination.

Accutron™ PIP+™ Nasal Masks are lightly scented and brightly colored and available in small, medium and large sizes. Unscented option also available. Not made with natural rubber latex.



Learn more about all our
[Accutron™ PIP+™ Nasal Masks](#)





Accutron™ PIP+™ Single-Use Nasal Masks (24/box)

33017-1	TOP SELLER Small Variety Pack 1 (Orange, Strawberry and Bubblegum)	\$144.00	33016-11	Medium Sassy Strawberry	\$144.00
33017-9	Small Unscented Grey	\$144.00	33016-12	Medium Birthday Bubblegum	\$144.00
33017-10	Small Outlaw Orange	\$144.00	33016-13	Medium Pina Colada	\$144.00
33017-11	Small Sassy Strawberry	\$144.00	33016-14	Medium French Vanilla	\$144.00
33017-12	Small Birthday Bubblegum	\$144.00	33016-15	Medium Perfect Peach	\$144.00
33017-17	Small Groovy Grape	\$144.00	33016-16	Medium Fresh Mint	\$144.00
33016-1	TOP SELLER Medium Variety Pack 1 (Orange, Strawberry and Bubblegum)	\$144.00	33015-3	TOP SELLER Large Variety Pack 3 (Mint, Peach and Vanilla)	\$144.00
33016-2	Medium Variety Pack 2 (Pina Colada, Vanilla and Orange)	\$144.00	33015-9	Large Unscented Grey	\$144.00
33016-3	Medium Variety Pack 3 (Mint, Peach and Vanilla)	\$144.00	33015-14	Large French Vanilla	\$144.00
33016-9	Medium Unscented Grey	\$144.00	33015-15	Large Perfect Peach	\$144.00
33016-10	Medium Outlaw Orange	\$144.00	33015-16	Large Fresh Mint	\$144.00

Accutron™ PIP+™ Adapters

35000	TOP SELLER Porter™ Brown Scavenging System Has four tubes – two ports on each side, mask within mask bearing the name “Brown.”	\$92.00
35100	Porter™ Clean Air Scavenging System Has tube inside tube and wings or vacuum sweeps to draw off excess gas.	\$42.00
35300	Matrx™ (Ohmeda) Scavenging System Has one smooth white tube on each side.	\$92.00
35350	Matrx™ Scavenging System Has one smooth, white tube on each side.	\$100.00
35400	McKesson® Scavenging System Has clear mask and one tube on each side.	\$42.00
35500	TOP SELLER Accutron ClearView™ Scavenging System Has four tubes - two ports on each side, colored and scented mask within clear outer mask.	\$92.00

Accutron™ PIP+™ Multi-Use Nasal Masks (Steam Sterilize)

33018	Multi-Use Large Mask 1 Each	\$176.00
33019	Multi-Use Medium Mask 1 Each	\$163.00
33020	Multi-Use Small Mask 1 Each	\$151.00

Accutron™ Personal Inhaler Plus+™ Nasal Masks connect effortlessly to Accutron™ Scavenging Circuit I (**33008** and **33010**) and Scavenging Circuit II (**32007** & **32009**). They also connect easily to any brand of scavenging system.



Capnography Adapters & Bundles

Our line of Capnography Adapters measure patients' end-tidal CO₂, attaching between the nasal mask and scavenging circuit with a female Luer-Lok® port, providing a secure connection to the capnography monitor's sample line.

Capnography sampling takes place within the nasal mask and directly measures the patient's exhalations at the source. These single-use capnography adapters connect to either side of the nasal mask for additional flexibility.



Attaches between the Mask and the Scavenging Circuit.

Accutron™ Axess™ Capnography Adapters

Our Accutron™ Axess™ Capnography Adapters attaches via a Luer, fitting to a capnography machine's sample line for the purpose of monitoring patient end-tidal CO₂.

53055	Accutron™ Axess™ Capnography Adapters 24/box	\$110.00
--------------	--	-----------------



Connect to capnography monitor sample line and verify patient end-tidal CO₂

Accutron™ ClearView™ Capnography Adapters

Our Accutron™ Clearview™ Capnography Adapters attach between Accutron™ ClearView™ Nasal Mask and scavenging circuit. Capnography sampling takes place within the nasal mask and directly measures patient’s exhalations at the source. A female Luer-Lok® port provides a secure connection to capnograph monitor sample line. Accutron™ Clearview™ Capnography Adapters connects to either right or left side of nasal mask for additional flexibility. They are single-use and individually wrapped to minimize cross-contamination. Bundled option with Accutron™ ClearView™ Nasal Masks are available for ease of ordering.

Accutron™ ClearView™ Capnography Adapters (12/box)

43055	Accutron™ ClearView™ Capnography Adapters	\$70.00
--------------	---	----------------

Accutron™ ClearView™ Nasal Mask with Capnography Adapter (12/box)

33037-9-CAP	Pediatric Unscented Grey	\$119.00	33035-12-CAP	Adult Birthday Bubblegum	\$119.00
33037-10-CAP	Pediatric Outlaw Orange	\$119.00	33035-14-CAP	Adult French Vanilla	\$119.00
33037-11-CAP	Pediatric Sassy Strawberry	\$119.00	33035-16-CAP	Adult Fresh Mint	\$119.00
33037-12-CAP	TOP SELLER Pediatric Birthday Bubblegum	\$119.00	33034-9-CAP	Large Adult Unscented Grey	\$119.00
33037-17-CAP	Pediatric Groovy Grape	\$119.00	33034-10-CAP	Large Adult Outlaw Orange	\$119.00
33035-9-CAP	TOP SELLER Adult Unscented Grey	\$119.00	33034-14-CAP	Large Adult French Vanilla	\$119.00
33035-10-CAP	Adult Outlaw Orange	\$119.00	33034-16-CAP	Large Adult Fresh Mint	\$119.00

Accutron™ Axess™ Scavenging Circuits	66
Accutron™ ClearView™ Scavenging Circuits	68
Accutron™ PIP+™ Scavenging Circuits	70

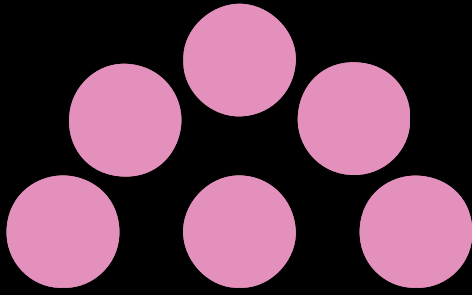

Scavenging Circuits

Scavenging is an important part of nitrous oxide/oxygen sedation since it carries the mixed gas to the patient, before being delivered through the nasal mask. Our Scavenging Circuits are sterilizable to meet current safety guidelines, and are available in a variety of configurations to suit your needs.



Learn more about all our
Scavenging Circuit products.



Accutron™ Axess™ Scavenging Circuits

Accutron™ Axess™ Scavenging Circuits are steam-sterilizable, making them an environmentally friendly and cost-effective solution for your practice. These slender, lightweight circuits are more comfortable for patients and allow unobstructed access for clinician. Accutron™ Axess™ Scavenging Circuits minimize drag and pull, so nasal masks stay in place.



Accutron™ Axess™ Low Profile Nasal Mask

52005

TOP SELLER

\$260.00



Accutron™ Axess™ Scavenging Circuit for In-line Vacuum Controller

Includes 6-foot long low profile scavenging circuit with In-line vacuum controller, complimentary low profile nasal mask assortment, adapters for connecting most non-Accutron vacuum controllers, instructions for use and reprocessing.

53004



Accutron™ Axess™ Extension Tube

\$80.00

32" autoclavable circuit that allows extension of Axess Scavenging Circuits [i.e., Axess™ Scavenging Circuit for In-line Vacuum Controller and Axess™ Scavenging Circuit for Remote Flow System (RFS) and Accu-Vac™.]

52006

Accutron™ Axess™ Scavenging Circuit for RFS™ Remote Flow System and Accu-Vac™ Vacuum Controller

\$236.00



Includes 6-foot long low profile scavenging circuit (to be used with RFS and Accu-Vac™ Vacuum Controllers – not provided), complimentary low profile nasal mask assortment, adapters for connecting most non-Accutron vacuum controllers, instructions for use and reprocessing.

28657-FRU



Accutron™ Axess™ Accessory Kit

\$60.00

Includes white cap, 90° outspout connector, universal vacuum adapter.



Accutron™ Axess™ Scavenging Circuit Components Diagram (standard in-line vacuum)

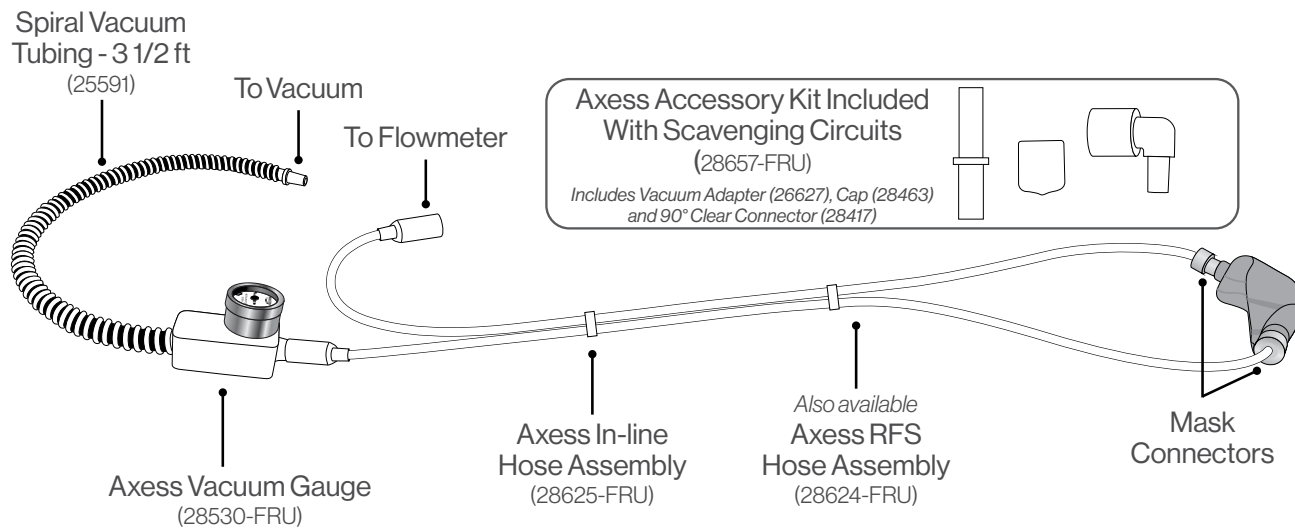

Note: For Axess™ Scavenging Circuits for Remote Flow System (RFS™) and Accu-Vac™ Vacuum Controller, part 28517-FRU is replaced with 28516-FRU, and parts 25591 and 28530-FRU are not included.



Accutron™ ClearView™ Scavenging Circuits

Accutron™ ClearView™ Scavenging Circuits are sterilizable and x-ray compatible. These products meet NIOSH and ADA flow rate recommendations and fit most brands of flowmeters.



Accutron™ ClearView™ Scavenging Circuits for Standard Bag Tee

43003	TOP SELLER ClearView™ Scavenging Circuit II (includes Scavenging Circuit with Vacuum Control Valve with White Spiral Tubing, Reservoir Bag, 3' Gray Corrugated Tube and complimentary ClearView™ Single-Use Nasal Masks)	\$996.00
43005	ClearView™ Scavenging Circuit I (includes Scavenging Circuit with Vacuum Control Valve & White Spiral Tubing, and complimentary ClearView™ Single-Use Nasal Masks)	\$872.00

Accutron™ ClearView™ Scavenging Circuits for Remote Flow Systems and Accu-Vac™

43004	ClearView™ Scavenging Circuit II (includes Scavenging Circuit, 6' White Spiral Tube, 3' Gray Corrugated Tube, Reservoir Bag and complimentary ClearView™ Single-Use Nasal Masks)	\$946.00
43006	ClearView™ Scavenging Circuit I (includes Scavenging Circuit, with 6' White Spiral Tubing and complimentary ClearView™ Single-Use Nasal Masks)	\$828.00
43009	TOP SELLER ClearView™ Scavenging Circuit Extra sterilizable components	\$300.00

Not made with natural rubber latex.



Accutron™ ClearView™ Scavenging Circuit Components Diagram (Standard Bag Tee)

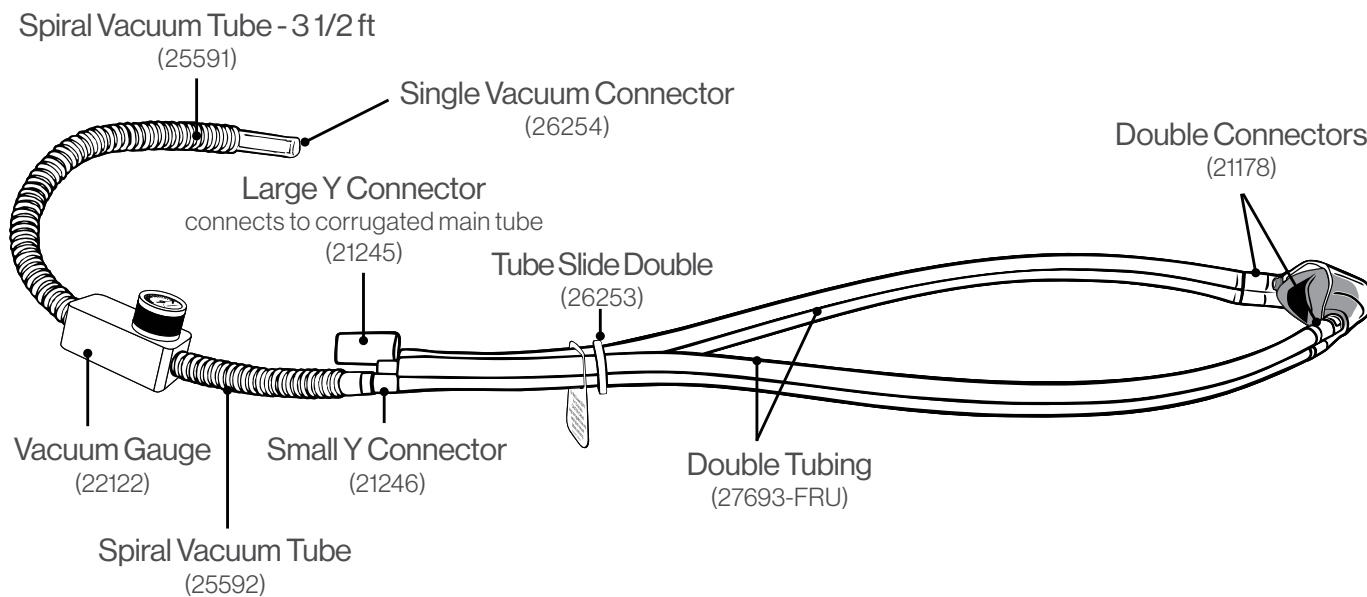

Note: For ClearView™ Scavenging Circuits for RFS and Accu-Vac, parts 25591, 22122, and 25592 are replaced with a 6' Spiral Vacuum Tube (part 27132)

Accutron™ PIP+™ Scavenging Circuits

Accutron™ PIP+™ Scavenging Circuits are sterilizable and x-ray compatible. These Scavenging Circuits meet NIOSH and ADA flow rate recommendations. The flexible system accommodates most brands of flowmeters. Not made with natural rubber latex.



Accutron™ PIP+™ Scavenging Circuits for Standard Bag Tee

32007	TOP SELLER Accutron™ PIP+™ Scavenging Circuit II (Includes Scavenging Circuit with Vacuum Control Valve, Corrugated Tube, Reservoir Bag and complimentary PIP+™ Single-Use Nasal Masks)	\$1,026.00
33010	Accutron™ PIP+™ Scavenging Circuit I (Includes Scavenging Circuit with Vacuum Control Valve and complimentary PIP+™ Single-Use Nasal Masks)	\$896.00
33011	Scavenger with Large Multi-Use Mask	\$918.00
33012	Scavenger with Medium Multi-Use Mask	\$918.00
33013	Scavenger with Small Multi-Use Mask	\$918.00

Accutron™ PIP+™ Scavenging Circuits for Remote Flow Systems & Accu-Vac™

32009	Accutron™ PIP+™ Scavenging Circuit II (includes Scavenging Circuit, Corrugated Tube, Reservoir Bag and complimentary PIP+™ Single-Use Nasal Masks)	\$974.00
33008	Accutron™ PIP+™ Scavenging Circuit I (includes Scavenging Circuit and complimentary PIP+™ Single-Use Nasal Masks)	\$854.00
33009	TOP SELLER Accutron™ PIP+™ Scavenging Circuit Extra sterilizable components	\$316.00

Accutron™ PIP+™ Scavenging Circuit Components Diagram (Standard Bag Tee)

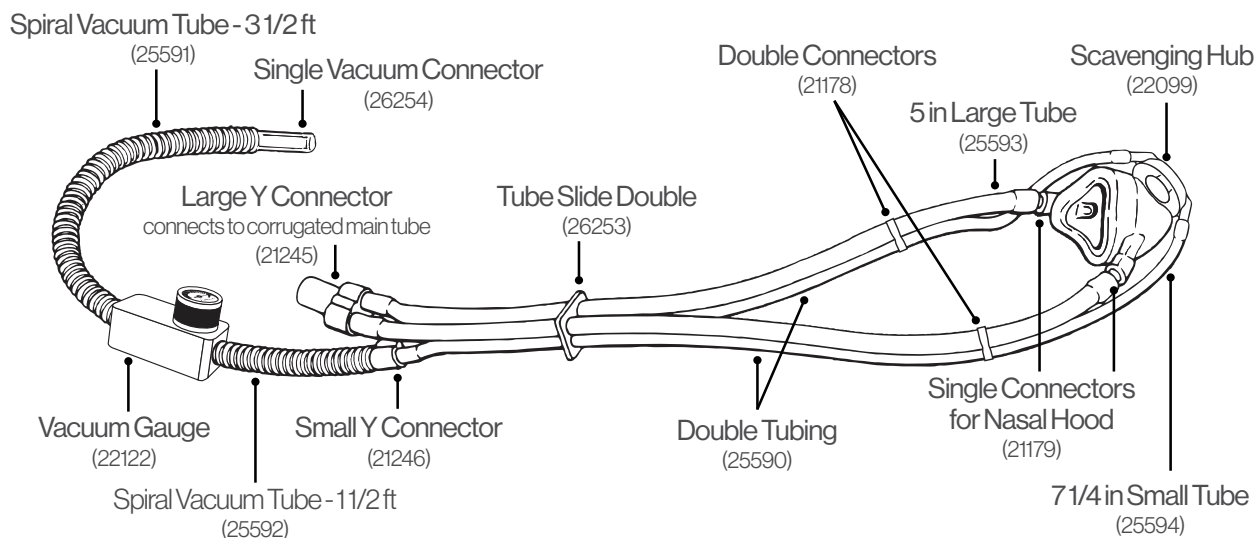

Note: For PIP+™ Scavenging Circuits for RFS™ Remote Flow System and Accu-Vac™ Vacuum Controller, parts 25591, 22122 and 25592 are replaced with a 6' Spiral Vacuum Tube (part 27132).

Emergency Oxygen Equipment

74

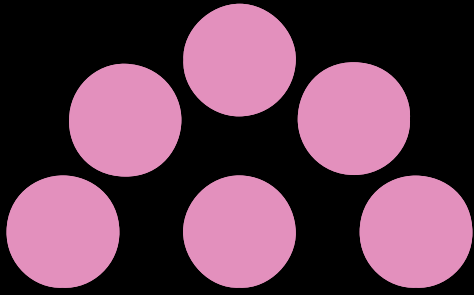

Oxygen Equipment & Components

Our reliable and readily accessible Oxygen Equipment & Components offer you assurance and peace of mind in the event you need to handle unexpected emergencies.



Emergency Oxygen Equipment

38013



Deluxe Portable Oxygen System \$2,000.00

Includes: Demand Valve with O₂ Q/C Fitting, Adult Facemask, Adjustable Liter Flow Regulator, In-line O₂ Adapter, Cylinder Wrench, Cart, and Regulator 35018 (gas cylinder not included)

38011



TOP SELLER

Demand Valve Resuscitator

Includes: Demand Valve, 6 ft O₂ Hose, O₂ Male Q/C Fitting

\$972.00

38010



Portable Oxygen System \$1,650.00

Includes: Demand Valve with O₂ Q/C Fitting, Adult Facemask, Cylinder Wrench, Cart, and Regulator 35013 (gas cylinder not included)

38007

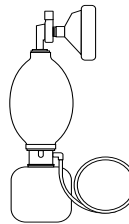

TOP SELLER Manual

Resuscitator with Bag, Valve, Mask and Oxygen Tube

\$424.00

38006



Portable Oxygen System \$1,130.00

Includes: Bag, Valve, Mask (Manual Resuscitator), Oxygen Tube, Cylinder Wrench, Cart and Regulator 35012 (gas cylinder not included)











26849-FRU













Oxygen Fitting - DISS with Female Q/C

\$148.00



38008	Full Facemask – Adult Replacement part for Demand Valve, Manual Resuscitator & Oral Surgery System	\$110.00	35018	Deluxe “E” Yoke Regulator with Content Pressure Gauge and Features Two 50 psi DISS Outlets and an Internal Liter-Flow Control with O ₂ Barb	\$728.00
					
38009	Full Facemask – Child Replacement part for Demand Valve, Manual Resuscitator & Oral Surgery System	\$110.00	35013	“E” Yoke Regulator with Content Pressure Gauge and Features a 50 psi DISS DISS Outlet	\$596.00
					
38001	E Cylinder Mobile Cart	\$292.00	35012	“E” Yoke Regulator Liter-Flow Control Knob, and O ₂ DISS with Barb Adapter included (P/N 24589)	\$640.00
					
33029-10	Pediatric Nasal Cannula with 7 ft Tubing (curved tips; Non-Latex; 10 per pkg.)	\$120.00	35014-U	TOP SELLER Oxygen Liter-Flowmeter (for use with oxygen outlets that do not have a hex nut)	\$302.00
					
33030-10	Adult Nasal Cannula with 7 ft Tubing (curved tips; Non-Latex; 10 per pkg.)	\$120.00	35014-HL	Oxygen Liter-Flowmeter (for use with oxygen outlets that have a hex nut, including stand-alone outlet 27793)	\$302.00
					

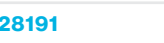

	34018 Oxygen Liter-Flow Mounting Bracket (for 35014-U)	\$132.00		27254-FRU Oxygen Fitting – DISS with Male Q/C without Bracket	\$124.00
	35015 Oxygen Liter-flow Selector Valve with Bracket (0 to 15 lpm) with O ₂ Barb and O ₂ Q/C Fitting (P/N 27775)	\$794.00		27775-FRU Oxygen Fitting – .13 in Male Pipe Thread with Male Q/C with Bracket	\$128.00
	35016 Oxygen Liter-flow Selector Valve without Bracket (0 to 15 lpm) with O ₂ Barb and O ₂ Q/C Fitting (P/N 27958)	\$794.00		27958-FRU Oxygen Fitting – .13 in Male Pipe Thread with Male Q/C without Bracket	\$128.00
	35017 Oxygen Liter-flow Selector Valve with 90° EII (0 to 15 lpm) with O ₂ Barb, Set-up for RFS™ Remote Flow System D	\$794.00		27793-FRU Oxygen Outlet – DISS with Female Q/C (for use with Digital Ultra RFS™ Chairmount Kits. Does not include riser and hoses.)	\$390.00
	27253-FRU Oxygen Fitting – DISS with Male Q/C with Bracket	\$126.00		24589-FRU Oxygen DISS with O2 Barb Fitting (green nut & nipple)	\$12.00
	27429 Extension, Oxygen Liter/Flowmeter	\$56.00			
	28191 Oxygen Splitter Assembly	\$248.00			

Oxygen Male Q/C (MQC) Chart

Connectors / Outlets	O ₂ Outlet	Micro O ₂ Outlet	Micro Double Outlet	Micro Triple Outlet	RFS™ System A	RFS™ System D	Accu-Vac™ Vacuum Controller	Ultra PC™ % Cabinet Mount Flowmeter	Ultra PC™ Flowmeter/ Ultra DC™ Flowmeter	Newport™ System
27253-FRU		•			•	•	•	•	•	•
27775-FRU		•			•	•*	•	•	•	•
27254-FRU	•	•	•	•	•	•	•	•	•	•
27958-FRU	•	•	•	•	•	•	•	•	•	•

* Note: 35017 O₂ Selector Valve can be attached to system if bag tee is removed, or adding a 90° "ell" and nipple will angle Selector Valve up and out of the way of the bag tee.

Rubber Goods & Other Components

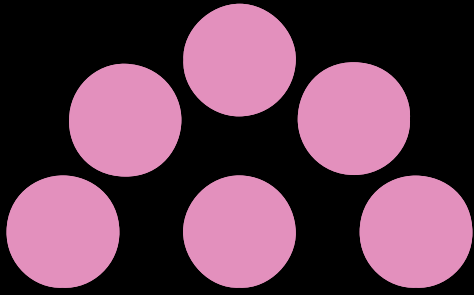

Rubber Goods & Other Components

Our wide variety of Rubber Goods & Other Components are latex-free replacement parts to keep on-hand to help you maintain your system when needed, helping you be the Best in Practice.



Rubber Goods & Other Components

Rubber Goods

22137-FRU 6' (72") Corrugated Tube **\$94.00**

33025 **TOP SELLER** Reservoir Bag – 3 Liter, 15" long **\$62.00**



33014 3' (36") Corrugated Tube **\$66.00**

33026 Reservoir Bag – 2 Liter, 12.3" long **\$60.00**



Scavenging Circuit Components

20009 Autoclave Leaf for PIP+ **\$3.00**

21245 Large Y Connector **\$50.00**



21178 **TOP SELLER** Double Connectors for PIP+™ Nasal Mask (2/pkg.) **\$50.00**

21246 Small Y Connector **\$50.00**





















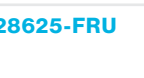

21179 **TOP SELLER** Single Connectors for PIP+™ Nasal Mask (2/pkg.) **\$50.00**

22099 **TOP SELLER** Scavenging Hub for PIP+™ Nasal Masks **\$80.00**





Scavenging Circuit Components *(Continued)*

	22122 Vacuum Controller w/ Gauge (for standard bag tee) for ClearView™ and PIP+™ Nasal Masks	\$256.00		25591 Spiral Vacuum Tube – 3 1/2'	\$38.00
	28530-FRU Vacuum Controller w/ Gauge for Axess™ In-line Scavenging Circuit	\$230.00		25592 Spiral Vacuum Tube – 1 1/2'	\$30.00
	28657-FRU Axess™ Accessory Kit (Includes: 90° Outspot Adapter, White Cap, Matrix™ Scavenger Adapter, Porter™ In-line Scavenger Adapter and Porter™ AVS Scavenger Adapter)	\$60.00		27132 6' Spiral Vacuum Tube (for RFS™ Scavenging Circuit)	\$62.00
	28463-FRU Vinyl Cap (7/8" x 1/2")	\$14.00		25593 TOP SELLER 5' Large Tube for PIP+™ Scavenging Circuit (order 2)	\$30.00
	28624-FRU Axess™ RFS Hose Assembly	\$258.00		25594 TOP SELLER 7 1/4" Small Tube for PIP+™ Scavenging Circuit (order 2)	\$32.00
	28625-FRU Axess™ In-Line Hose Assembly	\$258.00		26252 PIP+™ Scavenging Plug	\$42.00
	26253 Tube Slide Double	\$42.00		26254 Single Vacuum Connector (HVE adapter)	\$22.00
	25590 Double Tubing for PIP+™ Scavenging Circuit (order 2), 27.25" long	\$52.00		26255-FRU 90° Elbow (creates 90° angle off flowmeter for attachment of scavenging circuit)	\$42.00
	53004 Axess™ Extension Tube (tubing that extends the Axess™ Scavenging Circuit by 32")	\$80.00		27693-FRU Double Tubing for ClearView™ Scavenging Circuit (order 2) , 32" long	\$52.00
	28559-FRU Axess™ Scavenging Circuit to Accu-Vac™ Adapter	\$80.00		28146 Mixed Gas Tubing White, 25 ft	\$88.00



Top Replacement Parts

Bagtee

26798-FRU	Bagtee Assemblies (White)	\$180.00
26679-FRU	Bagtee Assemblies (Taupe)	\$222.00

27135	Outspout, Taupe	\$50.00
27761	Downspout, Taupe	\$14.00

Flowmeters & Flowmeter Carts

27514	Ultra PC™ Flushmount Flowmeter ONLY	\$2,575.00
27076	Digital Ultra™ Flushmount Flowmeter ONLY (control + main module)	\$4,180.00
27192-FRU	Digital Ultra™ Flowmeter Main Module Replacement	\$2,786.00
27112-FRU	Digital Ultra™ Flowmeter Control Module Replacement	\$948.00
26456-FRU	.5A Digital Ultra Fuse	\$12.00
27349-FRU	2" Replacement Casters (Brake)	\$22.00
27350-FRU	2" Replacement Casters	\$22.00
28736-FRU	3" Replacement Casters	\$32.00
28737	3" Replacement Casters (Brake)	\$32.00
24494	Replacement E-Washers	\$42.00

24491	Room-Air Override Replacement Kit	\$32.00
25746	O ₂ Regulator for Newport	\$464.00
25747	N ₂ O Regulators for Newport	\$464.00
26432-FRU	O ₂ Regulator for 4-Cylinder Stand	\$348.00
26433-FRU	N ₂ O Regulator for 4-Cylinder Stand	\$348.00
20096-FRU	O ₂ 4-Cylinder E-Yoke Replacement	\$180.00
20097-FRU	N ₂ O 4-Cylinder E-Yoke Replacement	\$180.00
23589-FRU	O ₂ Gauge for Newport	\$118.00
23590-FRU	N ₂ O Gauge for Newport	\$120.00
25095-FRU	O ₂ Gauge for 4-Cylinder Stand	\$88.00
25096-FRU	N ₂ O Gauge for 4-Cylinder Stand	\$88.00

Manifolds

26053-FRU	Digi-Flo Zone Valve Frame & Cover Plate	\$380.00
26053	Guardian Zone Valve Frame & Cover Plate	\$220.00
27901	Digi-Flo Bracket Riser	\$96.00
20503	Digi-Flo Alarm Box with Bracket	\$30.00
27672	Digi-Flo Alarm Panel Bracket	\$88.00
27224-FRU	Tank Room Label	\$12.00

28790-FRU	Manifold Solenoids (3 way NC/Gem Style Pilot)	\$210.00
26786-FRU	Manifold Solenoids (Accuvalve Assembly with Gem Style Solenoid)	\$354.00
25942-FRU	1A Digi-Flo Circuit Board Fuse	\$18.00
28133-FRU	2A Digi-Flo Circuit Board Fuse	\$22.00
28132-FRU	Digi-Flo Zone Valve Fuse	\$22.00
27780-FRU	In-Line Pressure Relief Valve, 80 PSI	\$234.00

Outlets

23913	O ₂ Primary Check Valve for Outlet Station	\$96.00
23914	N ₂ O Primary Check Valve for Outlet Station	\$96.00

24176	Vacuum Check Valve for Outlet Station	\$102.00
--------------	---------------------------------------	-----------------

RFS

27366	Mixed Gas Barb for RFS blocks	\$12.00
25967	Vacuum Thread for back of RFS blocks	\$38.00

20520	O ₂ Thread for back of RFS blocks	\$14.00
28327-FRU	Vacuum Control, RFS	\$362.00

Scavenging & Tubing

22122	In-Line Vacuum Controller (PIP & ClearView)	\$256.00
28530-FRU	In-Line Vacuum Controller (Axess)	\$230.00
33014	Corrugated Tubing 3 ft.	\$66.00
22137-FRU	Corrugated Tubing 6 ft.	\$94.00

23092	Mixed Gas Hose, by foot	\$8.00
28146	Mixed Gas Hose, 25 ft.	\$88.00
28145	Mixed Gas Hose, 10 ft.	\$38.00
20212	Spiral Vacuum Tubing, by foot	\$12.00

The Best In Practice

Hu-Friedy Mfg. Co., LLC, 1666 E. Touhy Ave., Des Plaines, IL 60018 | HuFriedyGroup.com

Accutron™, Accu-Vac™, Axess™, ClearView™, Guardian Monitor™, Digital Ultra™, Digi-Flo™, Newport™, PIP+™, Personal Inhaler Plus+™, RFS™, Ultra DC™, and Ultra PC™ are trademarks of Hu-Friedy Mfg. Co., LLC. All other product and company names referenced are trademarks of their respective owners.

Pricing is subject to change at any time. Please consult Price List.

©2025 Hu-Friedy Mfg. Co., LLC. All rights reserved. HFL-599/1024

 **HuFriedyGroup**

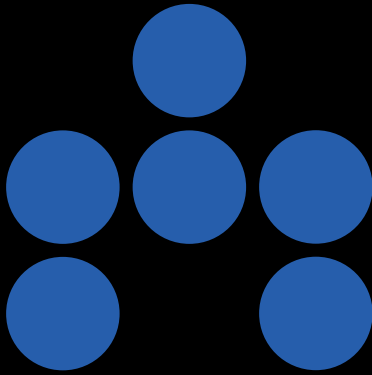

Sterilization Center Water Solutions

HuFriedyGroup offers a comprehensive range of water treatment and wastewater management products for sterilization centers. Our products are designed to help you ensure the highest quality water is used in your sterilization processes, while also reducing your workload and protecting your equipment.



The long and narrow design of DUWLs creates the perfect breeding ground for microbial growth. When untreated, or improperly maintained, the water flowing through these contaminated DUWLs and out through dynamic instruments used during treatment can potentially harm your patients, staff and practice reputation. VistaClear™ DP Centralized Waterline Treatment System continuously delivers compliant patient treatment water directly to the dental unit.



Learn more about our **Continuous Treatment** products.

VistaClear™ DP Centralized Waterline Treatment System

The VistaClear™ DP Centralized Waterline Treatment System filters water centrally for directly connected dental operatories and provides a method for delivering compliant*, on-demand procedural water with reduced microbial contamination (<200 CFU/mL) and odor-causing bacteria buildup when used with the EPA registered DentaPure™ Cartridge. It eliminates the need for dental bottles and water-storage tanks, and the need for purchased water and waterline tablet treatments for bottle systems.



Learn more about our **VistaClear™ Centralized Waterline Treatment System**.



VistaClear™ DP Centralized Waterline Treatment System	
CVV1000-DP	\$7,000.00

Annual Replacement Cartridges for VistaClear™ DP Waterline Treatment System		
DentaPure™ Cartridge	DP365VC	\$1,117.80
VistaClear™ DP Carbon Block Filter	CVR9725	\$196.30

Water Purification

Poor water quality can damage dental instruments inside instrument washers or interfere with proper sterilization. The VistaPure™ Water Purification System eliminates the need to buy bottled water, distilled water or own a distiller with one convenient system.



Learn more about our [Sterilization Center Water Solutions.](#)

VistaPure™ Water Purification System

VistaPure™ Water Purification System produces two grades of high-purity water for autoclaves, dental bottles, ultrasonic cleaners and the rinse cycle of instrument washers. It connects directly to the city water supply and sends purified water anywhere it's needed in the steri-center for easy, on-demand use. Optional, autofill devices replenish SciCan STAT/M® Autoclave and BRAVO™ Autoclave reservoirs automatically, enabling truly hands-free convenience. Optional adapter kit sends high-purity water to instrument washers with final-rinse ports to help protect dental instruments from poor-quality water.

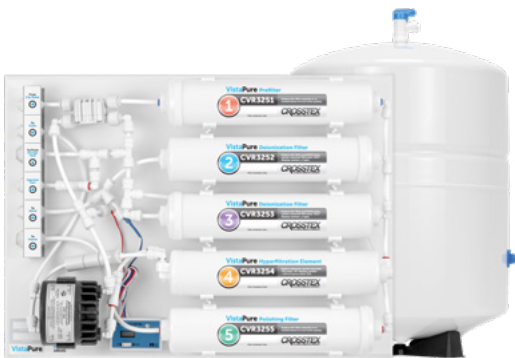

VistaPure™ Water Purification System
CVV3000 \$3,666.00

VistaPure™ Instrument Washer Adapter Kit	CVS3010	\$80.65
VistaPure™ STATCLAVE® Adapter Kit	CVS3015	\$45.55
VistaPure™ AutoFill Kit for SciCan STAT/M® Autoclave	CVS3020	\$231.50
VistaPure™ AutoFill Kit for SciCan BRAVO™ Autoclave	CVS3030	\$289.25
VistaPure™ Replacement Filter – Prefilter (#1)	CVR3251	\$83.75
VistaPure™ Replacement Filter – Deionization Filter (#2)	CVR3252	\$121.05
VistaPure™ Replacement Filter – Deionization Filter (#3)	CVR3253	\$121.05
VistaPure™ Replacement Filter – Hyperfilter (#4)	CVR3254	\$242.70
VistaPure™ Replacement Filter – Polishing Filter (#5)	CVR3255	\$83.75
VistaPure™ Legacy Filter – Polishing Filter (#5)	CVR2551	\$83.75
VistaPure™ Water Storage Tank (4.25 Gallon)	CVS9111	\$346.20
VistaPure™ Water Storage Tank (9.5 Gallon)	CVS9113	\$585.25
VistaPure™ Autoclave Wand	CVS9300	\$182.35
VistaPure™ BottleFill Remote Water Dispenser	CVS3050	\$233.80



Wastewater Management

The wastewater produced during the process of steam sterilization can often be problematic. Many autoclaves discharge steaming-hot condensation after each sterilization cycle, which is typically collected in a bottle that dental staff members must monitor continuously and empty manually throughout the week. Not only is this process time-consuming and inefficient, but steam and spills from condenser bottles can also damage sterilization center cabinetry.



Learn more about our [Wastewater Management](#) products.

VistaCool™ Direct-to-Drain Cooling System

The VistaCool™ Direct-to-Drain Cooling System protects drains by preventing autoclave wastewater from melting plumbing. It also protects cabinets by helping to prevent mildew, rot, rust and delamination caused by spills and humid environments created by autoclave condenser bottles. VistaCool™ System saves staff time by eliminating the need to empty steaming-hot water bottles manually.



VistaCool™ Single-Autoclave Cooling System
CVV7501 \$1,060.00

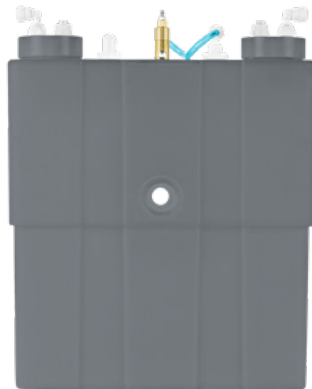

VistaCool™ Double-Autoclave Cooling System
CVV7502 \$1,417.00

VistaCool™ Adjustable Tank Stand for Single-Autoclave Cooling System
CVS7545 \$152.90

VistaCool™ Adjustable Tank Stand for Double-Autoclave Cooling System
CVS7547 \$159.75

VistaCool™ Adapter Kit for Midmark® M9® & M11® Autoclaves
VS7560 \$174.75

Accessories

VistaCheck™ Backflow Preventer

VistaCheck™ Backflow Preventer is a QAI certified dual check valve backflow prevention device that can eliminate the need for reduced pressure zone (RPZ) valves, vacuum breakers, and air gaps. It's made from medical-grade components suitable for food contact. Generally accepted by state and local code authorities as suitable for backflow and cross-connection protection.



VistaCheck™ Dual Check Valve Backflow Preventer		
1/4" (6.35 mm)	CVVC250-A	\$153.35

DrainHub™ Drain Adapter

The DrainHub™ Drain Adapter is QAI certified and accepts up to eight drain connections in one small hub, saving space, cost and time. It is easy to install: top and bottom slip hubs accept 1-1/2" pipe; bottom hub glues into 2" coupling. DrainHub Drain Adapter has 1/2" NPT threaded ports accept a variety of push-to-connect, compression, and hose barb adapter fittings.



DrainHub™ Multi-Port Drain Adapter		
8-Port	CVDH158	\$70.50

DrainHub™ Fittings Accessory Kit		
20 Fittings	VDH8200	\$77.55

DrainHub™ (8-Port) with Fittings		
Accessory Kit	CVDH158-82	\$153.00

*Compliance = Compliance with current EPA potable water standard of <500 CFU/mL.

Note: some of the devices, products, and/or programs advertised may not be licensed for sale outside the United States. Contact your local sales or customer care representative for availability details. For full product warranty details, please visit [HuFriedyGroup.com/services/warranties](https://www.hufriedygroup.com/services/warranties)

The contents of this catalog including, but not limited to, all text, photographs and graphics, are the sole and exclusive property of Hu-Friedy Mfg. Co., LLC its affiliates or related companies and may not be copied, reproduced or distributed without prior written permission.

Hu-Friedy Mfg. Co., LLC, 1666 E. Touhy Ave., Des Plaines, IL 60018 | [HuFriedyGroup.com](https://www.hufriedygroup.com)

All company and product names are trademarks of Hu-Friedy Mfg. Co., LLC its affiliates or related companies, unless otherwise noted. STAT/M®, STATCLAVE® and BRAVO™ are registered trademarks and trademarks of SciCan Ltd. Midmark®, M9® and M11® are registered trademarks of Midmark Corporation. VistaCheck™ and DrainHub™ are trademarks of Vista Research Group, Inc.

